

EXPERIENCE COUNTS



APPROVED
THE INDUSTRY'S HEAVY DUTY
PENETRATION SEAL

THUNDERLINE
Link-Seal
MODULAR SEALS

Century-Line
Century-Line
SLEEVES

Cell-Cast
Cell-Cast
DISKS

Engineering Manual and Buyers Guide

*Product enhancements and
sizing charts updated 2-11*

Link-Seal® Modular Seals
Century-Line® Sleeves
Cell-Cast® Disks



WILLIAM JOHNSTON
& COMPANY LIMITED



Glasgow Tel: +44 (0) 141 620 1666 | Inverness Tel: +44 (0) 1463 238 673
sales@williamjohnston.co.uk | www.williamjohnston.co.uk

YOUR OFFICIAL UK DISTRIBUTOR FOR LINK-SEAL

Use the original engineered fit for pipes passing
through walls, floors and ceilings...
there are no performing equals!

Table of Contents



Link-Seal® Modular Seals

- The System is the Solution 3
- Technical Approvals 3
- Features 4
- Applications 4
- Model Options - Material Properties 5
- Dimensional Data 6
- Link-Seal® Sizing Method (Updated) 7
- Sizing Procedure - Method 1 8-11
- Sizing Procedure - Method 2 12
- Suggested O.D. Pipe Ranges 12
- Sizing Procedure - Method 2 (Verification) 13-14

Century-Line® Sleeves

- Features 15
- Weights and Dimensional Data 15

Cell-Cast® Disks

- Features 16
- Weights and Dimensional Data 16

Type WS Steel Wall Sleeves

- Weights Dimensional Data and Specification 17

Technical/Engineering

- Link-Seal® Modular Seal Bolt Test Results 17

Note: The Link-Seal® sizing charts in printed issues LSEM/10-04, PSI-LSCCLC-2/05 and LSEM/8-06 are still valid fits for field applications. It's suggested you use the latest updated provided sizing.

CAD Drawings - Submittals

CAD drawings (.dwg) are available on-line. Drawings can be download and inserted into AutoCAD for drawing plans. Submittal sheets can also be accessed in a PDF file. Contact William Johnston & Company Limited for support and purchasing information.

Link-Seal Modular Seals- Specialty Applications

- Steel Pipe Reference Schedules 18
- Fire Seals 19
- Sealing Pipeline Casings 20
- Sealing An Oversize Annulus 21
- Pressure Testing 21
- Sealing Manhole Penetrations 21

Installation Techniques

- Link-Seal® Modular Seal Installation 22
- Century-Line® Sleeve Installation 23
- Cell-Cast® Disk Installation 24

- Product Ordering Code 25
- Typical Specification 26
- Frequently Asked Questions 27
- Warranty and Conditions of Sale 28

Updated engineering catalogs, literature, CAD Drawings, submittals and installation techniques are available on-line at: www.linkseal.com

Performance data included in this manual is intended for guideline purposes only. Performance suitability for any specific application should be determined by the user. Variation in temperature, pressure, concentration or mixtures acting synergistically may preclude recommended service use.



LINK-SEAL® MODULAR SEALS WITH CENTURY-LINE® SLEEVES
MANUFACTURED BY PIPELINE SEAL & INSULATOR, INC.
HOUSTON, TEXAS, U.S.A. TEL: 800-423-2410 E-MAIL: INFO@PSPI.COM

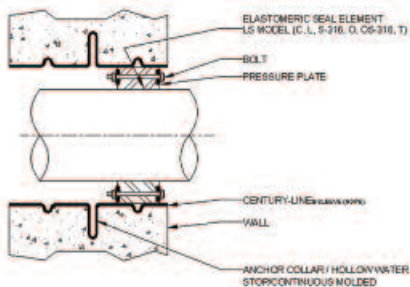

LINK-SEAL® MODULAR SEALS WITH MODEL WS STEEL WALL SLEEVES
MANUFACTURED BY PIPELINE SEAL & INSULATOR, INC.
HOUSTON, TEXAS, U.S.A. TEL: 800-423-2410 E-MAIL: INFO@PSPI.COM

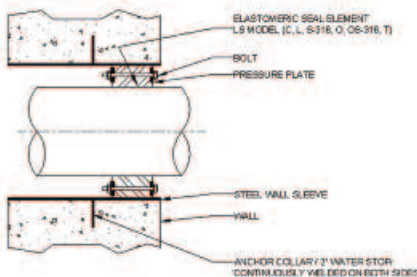

LINK-SEAL® MODULAR SEALS WITH CAST OR CORE DRILLED WALL OPENING
MANUFACTURED BY PIPELINE SEAL & INSULATOR, INC.
HOUSTON, TEXAS, U.S.A. TEL: 800-423-2410 E-MAIL: INFO@PSPI.COM

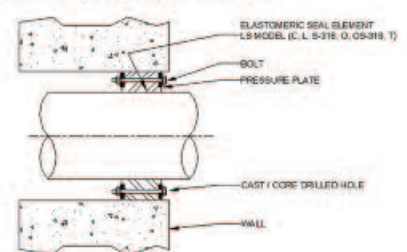

The System is the Solution.

Link-Seal® Modular Seals...

The best way to permanently seal any cylindrical object, of any size, passing through any type of concrete barrier (wall, floor or ceiling) is to use Link-Seal® modular seals. From ductile iron to pre-stressed concrete to metal or plastic pipe, conduit or cables - whatever your application - Link-Seal® modular seals will effect a hydrostatic seal capable of holding 20 psig (40 feet of static head) between the pipe and the penetration cylinder through which the pipe passes.



in combination with Century-Line® sleeves...

The best way to guarantee a perfect seal is to use Century-Line® sleeves with Link-Seal® modular seals. They're engineered and sized to provide a stable hole that matches dimensionally with Link-Seal® modular seals. It makes ordering quick and easy and guarantees a perfect fit - and seal - each and every time.

or Cell-Cast® disks.

For larger holes in poured concrete structures, (29.25" to 64.75"Ø) Cell-Cast® disks are used to produce a dimensionally stable hole and smooth concrete surface that is perfect for use with Link-Seal® modular seals.



Link-Seal® Modular Seal Technical Approvals

The following is a partial listing of the many Federal agencies, associations, code groups, laboratories and organizations which have approved, listed, specified, tested or otherwise indicated acceptance of Link-Seal® modular seals.

General Code Groups, Associations, Laboratories and Approval Authorities

AWWA - American Water Works Association
 API - American Petroleum Institute
 TÜV - Technischer Überwachungs-Verein
 Bureau Veritas - Marine Division
 ASME - American Society of Mechanical Engineers
 DNV - Det Norske Veritas

FM - Factory Mutual Engineering Corporation
 LLOYD'S - Lloyd's Register of Shipping
 NACE - National Association of Corrosion Engineers

Governmental Agencies

Bureau of Public Roads - Division of Bridges
 United States Coast Guard
 Corps. of Engineers
 GSA - General Services Administration
 Military Specifications
 TVA - Tennessee Valley Authority
 ARRA- American Recovery Reinvestment Act

Link-Seal® Modular Seal Applications

- Mechanical Contractors - Interior Piping Systems
- Manhole Pipe Entry Seals
- Waste Treatment Plants
- Cased Road Crossings
- Thermal Storage Systems
- Fire Protection Wall Penetrations
- Cased Railroad Crossings
- Electrical Isolation of Pipes
- Precast Concrete Vault Seals
- Insulated Pipe Seals
- Dual Containment Seals
- Marine Applications
- Noise Dampening
- Flexible Sign & Pole Supports
- Electrical Isolation of Pipe Supports
- Mining
- Pulp & Paper
- Decorative Fountains
- Pool Contractors
- Electrical Contractors
- Waste & Water Treatment
- Telecommunications
- Valve Pits
- Refrigeration Buildings
- Guard Post Assemblies
- Power Generation Dams
- Offshore Oil Rigs
- High Pressure Tank Guards
- Underground Steel Tanks
- Precast Concrete Manufacturers
- Perimeter Berm Installations Around Tank Farms
- Flow Restrictors in Sewer Maintenance
- Fluid Overflow Devices
- Noise and Sway Dampener
- Through Deck Fire Breaks
- Bridge Construction
- Septic Tank Installations
- Coal Preparation Plants
- Tunneling Operations



Link-Seal® Modular Seal Features

Saves time and money...

Link-Seal® modular seals install in up to 75% less time when compared to lead-oakum joints, hand fitted flashings, mastics or casing boots.

Positive hydrostatic seal...

Link-Seal® modular seals are rated at 20 psig (40 feet of head), which exceeds the performance requirements of most applications.

Long seal life...

Link-Seal® modular seals are designed for use as a permanent seal. Seal elements are specially compounded to resist aging and attack from ozone, sunlight, water and a wide range of chemicals.

Maximum protection against corrosion

Fasteners employ the use of a proprietary coating process on carbon steel. For extremely corrosive environments, corrosion resistant 316 stainless steel hardware is offered as a standard.



ISO Quality Assurance...

Link-Seal® modular seals are manufactured in an ISO 9001:2008 certified facility. In addition, they are completely manufactured and assembled in the U.S.A.

Certification/Approvals...

Factory Mutual Approval.
Det Norske Veritas Marine Deak/Bulkhead Penetration Certification.
Also a wide variety of approvals from various Federal agencies, associations, code groups, laboratories and organizations.

Configure a Link-Seal® modular seal to match your application...

Color coded EPDM, Nitrile, & Silicone elastomers may be used with various hardware options to match performance characteristics with service conditions.

Choose a Link-Seal® modular seal to match your pipe size and wall opening...

Link-Seal® modular seals are now available in 16 sizes to provide a solution for varying pipe penetration applications.

Link-Seal® Sizing Method

Pipeline Seal & Insulator, Inc. has re-evaluated the Link-Seal® modular seal standard sizing for the sizing charts that are included in this Engineering Manual and our Selection Guide. The updated Link-Seal® sizing method puts the most rubber in the hole. Please see the graphic, listed features, and sizing chart examples below for a complete understanding of the Link-Seal® sizing method. This updated method benefits the engineer, owner and contractor.

Features: More Rubber in Annular Space = Better Performing Seal

- Improved engineered fit.
- Improved vibration dampening.
- Minimum loads on bolts and pressure plates with same sealing effect.
- Most sealing pressure/most volume of sealing element in penetration.
- Curvature of link sized to penetration O.D. and I.D. for smooth fit.

In accomplishing putting more rubber in the annular space, the Link-Seal® assembly may require a larger size link with less links per belt or a smaller size link with more links per belt. Sleeve and cored hole sizing has also been taken into consideration. The charts below show examples comparing previous chart selections and the updated chart selections.

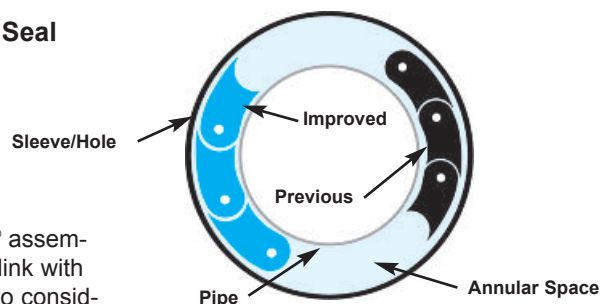

Compare: Solutions in Bolded Blue = Updated Link-Seal® Sizing Method.

Steel and Plastic Pipe with Same Outside Diameter

PIPE SIZE (Nom.)	ACTUAL O.D. (Inches)	CS MODEL NON-METALLIC SLEEVE			WS MODEL STEEL SLEEVE			CAST OR CORE BIT DRILLED HOLE		
		MODEL NUMBER	LINK-SEAL® SIZE	LINKS PER SEAL	MODEL NUMBER	LINK-SEAL® SIZE	LINKS PER SEAL	HOLE I.D.	LINK-SEAL® SIZE	LINKS PER SEAL
3	3.500	CS-5-*	LS-300-***	8	WS-5-25-S-*	LS-300-***	8	5.000	LS-300-***	8
3	3.500	CS-5-*	LS-300-***	8	WS-6-28-S-*	LS-360-***	7	5.000	LS-300-***	8
10	10.750	CS-14-*	LS-400-***	10	WS-14-37-S-*	LS-425-***	10	14.000	LS-400-***	10
10	10.750	CS-14-*	LS-410-***	15	WS-14-37-S-*	LS-425-***	10	14.000	LS-475-***	14
16	16.000	CS-20-*	LS-400-***	15	WS-20-37-S-*	LS-400-***	15	20.000	LS-575-***	18
16	16.000	CS-20-*	LS-410-***	21	WS-20-37-S-*	LS-475-***	21	20.000	LS-575-***	18

Link-Seal® Sizing Alternatives

Experience Counts... There are a lot of sizing solutions for a particular application. (See 16" D.I. Pipe Example) →

For the best/improved solution for either existing or new penetrations, let our vast network of experienced personnel assist you in correctly sizing the best solution using one of the 16 unique sizes of links available in 4 sealing elements. If your application is not in the provided charts; use Method 2 sizing, contact PSI or an authorized Link-Seal® distributor.



Example: A Ductile Iron Pipe 16" Cored Hole

Ductile Iron	Link-Seal® Size, # Links	Cored Hole Size
DI 16"	LS-340-***-37	20" Cored Hole
DI 16"	LS-360-***-27	20" Cored Hole
DI 16"	LS-425-***-16	20" Cored Hole
DI 16"	LS-500-***-16	22" Cored Hole
DI 16"	LS-525-***-16	22" Cored Hole
DI 16"	LS-575-***-19	22" Cored Hole
DI 16"	LS-600-***-10	24" Cored Hole



Link-Seal® Modular Seal Model Properties

with EPDM Seal Elements



EPDM (Black)
EPDM (Blue) Low Durometer

Model “C” or “L” Link-Seal Modular Seal
Suitable for use in water, direct ground burial and atmospheric conditions. Provides electrical isolation where cathodic protection is required.

Type: Standard
Seal Element: EPDM (Black) or EPDM (Blue)
Pressure Plates: Reinforced Nylon Polymer
Bolts & Nuts: Steel with 2-part Zinc Dichromate & proprietary corrosion inhibiting coating.
Temp. Range: -40 to +250°F (-40 to +121°C)*

* = Sustained operation near temperature limits may affect life expectancy.

Model “S-316” or “LS-316 Link-Seal Modular Seal
For chemical processing & waste water treatment. EPDM rubber is resistant to most inorganic acids and alkalis, some organic chemicals (acetone, alcohol, ketones).

Type: Stainless
Seal Element: EPDM (Black) or EPDM (Blue)
Pressure Plates: Reinforced Nylon Polymer
Bolts & Nuts: 316 Stainless Steel
Temp. Range: -40 to +250°F (-40 to +121°C)*



EPDM (Black)

Model “S61” Link-Seal Modular Seal

NSF 61 Certified for use in potable water (drinking water).

Type: Stainless
Seal Element: EPDM (Black)
Pressure Plates: Blue Reinforced Nylon Polymer
Bolts & Nuts: 316 Stainless Steel.
Temp. Range: -40 to +250°F (-40 to +121°C)*

* = Sustained operation near temperature limits may affect life expectancy.



NSF Certified

with Nitrile Seal Elements



Nitrile (Green)

Model “O” Link-Seal Modular Seal

Nitrile rubber is resistant to oils, fuel and many solvents (gasoline, motor oil, kerosene, methane, jet fuel, hydraulic fluid, water, etc.).

Type: Oil Resistant
Seal Element: Nitrile (Green) Note: Not U.V resistant.
Pressure Plates: Reinforced Nylon Polymer
Bolts & Nuts: Steel with 2-part Zinc Dichromate & proprietary corrosion inhibiting coating.
Temp. Range: -40 to +210°F (-40 to +99°C)*

Model “OS-316” Link-Seal Modular Seal
Combination of oil resistant rubber and stainless steel hardware.

Type: Oil Resistant
Seal Element: Nitrile (Green) Note: Not U.V resistant.
Pressure Plates: Reinforced Nylon Polymer
Bolts & Nuts: 316 Stainless Steel
Temp. Range: -40 to +210 °F (-40 to +99°C)*

* = Sustained operation near temperature limits may affect life expectancy.

with Silicone Seal Elements



Silicone (Grey)

Model “T” Link-Seal Modular Seal

Silicone rubber is ideal for temperature extremes. The “T” model is one-hour Factory Mutual approved.

Type: High/Low Temperature
Seal Element: Silicone (Grey)
Pressure Plates: Steel Zinc Dichromate
Bolts: Steel with 2-part Zinc Dichromate & proprietary corrosion inhibiting coating.
Temp. Range: -67 to +400°F (-55 to +204°C)*

Model “FD/FS” Link-Seal Modular Seal

Double seal for added protection.

Type: Fire Seals
Seal Element: Silicone (Grey)
Pressure Plates: Steel zinc dichromate
Bolts: Steel with 2-part Zinc Dichromate proprietary corrosion inhibiting coating.
Temp. Range: -67 to +400°F (-55 to +204°C)*

NOTE: Sustains a constant temp. of 325°F. (163° C.)
* = Sustained operation near temperature limits may affect life expectancy.

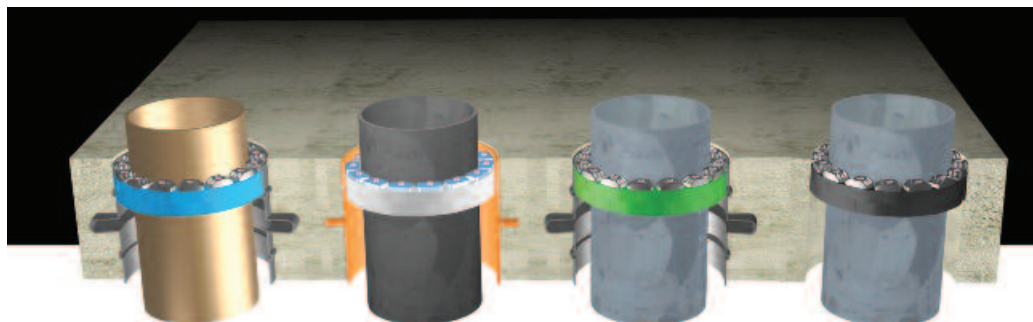



Link-Seal® Modular Seal Model Properties

Material Properties of Link-Seal Modular Seal Elements

PROPERTY	ASTM METHOD	EPDM (EPDM L)	NITRILE	SILICONE
Hardness (shore A)	D-2240	50 ±5 (40 ±5)	50 ±5	50 ±5
Tensile	D-412	1450 psi	1300 psi	860 psi
Elongation	D-412	400%	300%	250%
Compression Set	S-395	15%	45%	40%
		22 hrs. @ 158°F (70°C)	22 hrs. @ 212°F (100°C)	22 hrs. @ 350°F (177°C)
Specific Gravity	D-297	1.10	1.15	1.40

Material Properties of Composite Pressure Plates

PROPERTY	ASTM METHOD	VALUE
Izod Impact - Notched	D-256	2.05 ft-lb/in
Tensile Strength @ Yield	D-638	20,000 psi
Tensile Strength - Break	D-638	20,250 psi
Flexural Strength @ Yield	D-790	30,750 psi
Flexural Modulus	D-790	1,124,000 psi
Elongation, Break	D-638	11.07%
Specific Gravity	D-792	1.38
Moisture Content	--	0.18%

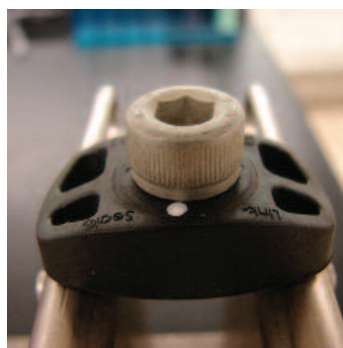

Independent Laboratory Test

The Newly Engineered Force Dispersion Pressure Plates have been fully tested by an independent laboratory to ensure design theory translates into the capability to handle the rigors of real world applications.

In addition, the new design has an average of 15% more strength than previous Link-Seal® Modular Seal versions.

Bolt & Nut Specifications

Standard: Carbon Steel

Carbon steel, zinc dichromated per ASTM B633, with an additional corrosion inhibiting proprietary organic coating. (passes 1470 hour salt spray test)

Tensile Strength = 60,000 psi, minimum.

An independent 1,470 hour salt spray test run in accordance to ASTM B117-97 has proven Link-Seal® modular seals' Zinc Dichromated Carbon Steel bolts, with proprietary corrosion inhibiting coating, to be superior when compared with competitive manufactures.

Test Criteria

Bolts subject to exposure in Salt Spray Cabinet for 1,470 hours according to ASTM B117-97.

The Link-Seal® Zinc Dichromated Carbon Steel bolt with proprietary corrosion inhibiting coating will provide greater resistance to the most hostile environmental conditions on earth.

Option: Stainless Steel

ANSI Type = 316, Per ASTM F593-95

Tensile Strength = 85,000 psi, average.



To provide consistency and worldwide compatibility, PSI now offers all Link-Seal® Modular Seal sizes with metric bolts. The new bolts adhere to metric specifications as used by most all countries outside the U.S.A. Smaller Link-Seal® Modular Seals (sizes LS-200, LS-275, LS-300, and LS-315) will consist of metric Allen head or socket cap bolt heads while the balance of the line will use standard hex head metric bolts.

1,470 hour salt spray test performed by an independent laboratory. Test results are available on request.

Link-Seal® Model	Tool Size/Type Req.	Bolt Head Type
LS-200, LS-275	4mm, Allen	
LS-300, LS-315	6mm, Allen	
LS-325, LS-340, LS-360	13mm, Hex	
LS-400, LS-410, LS-425, LS-475	17mm, Hex	
LS-500, LS-525, LS-575	19mm, Hex	
LS-600	30mm, Hex	
LS-650	19mm, Hex	



Dimensional Data

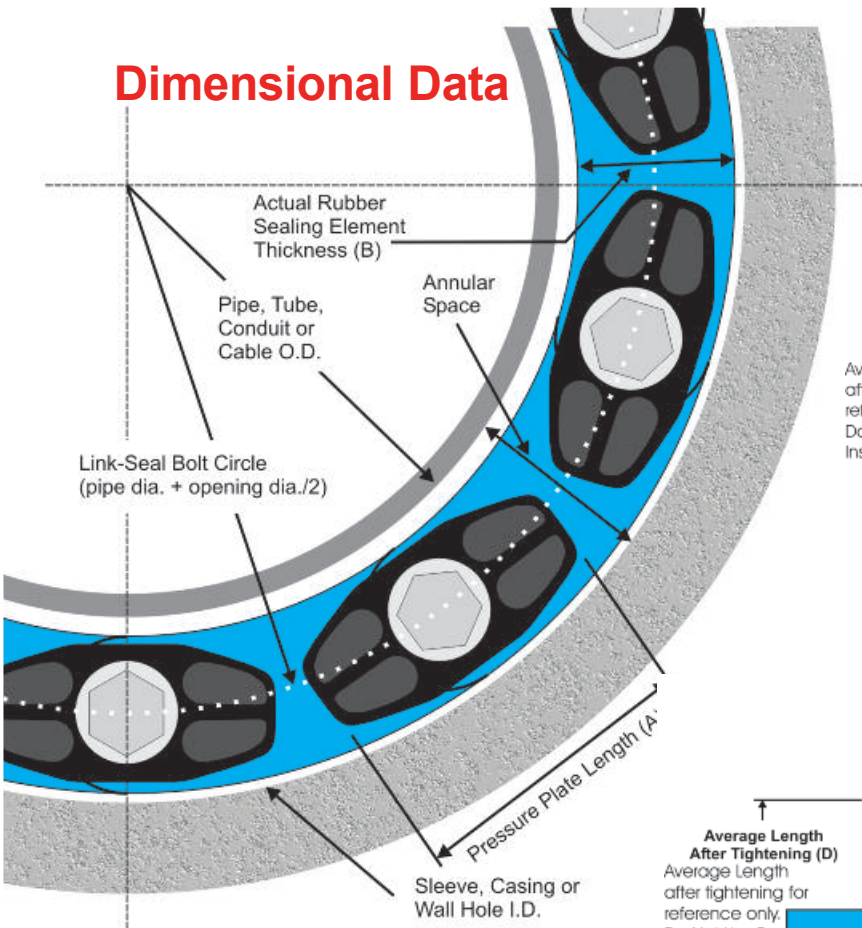

For LS-200 through LS-315

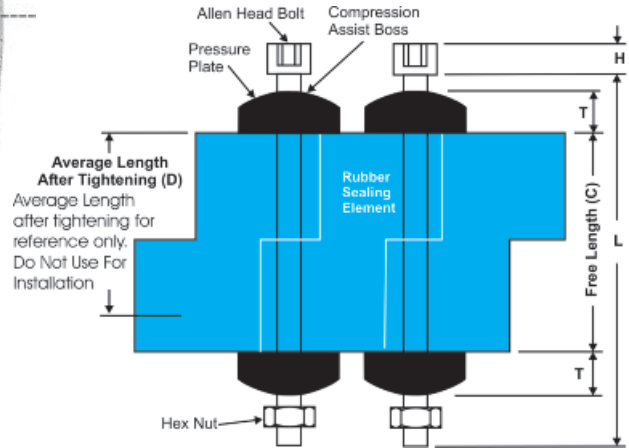

For LS-325 through LS-650

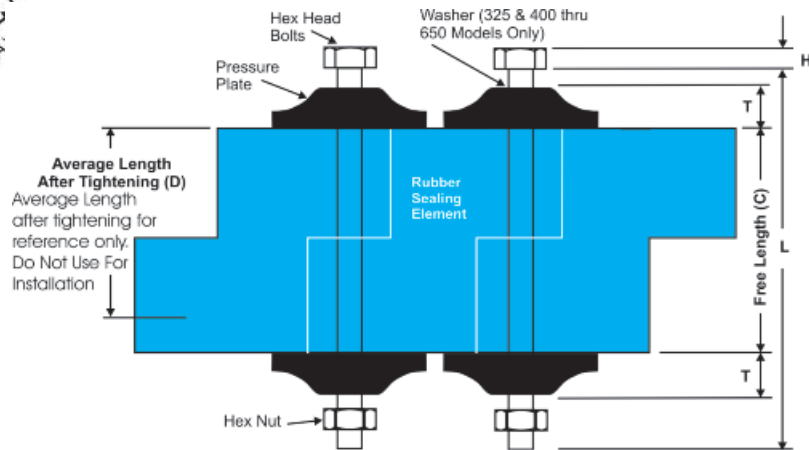

*Dimensional Data for Models C, L, O, S-316, S61, LS-316 and OS-316

LINK-SEAL MODEL NO.	RUBBER SEALING ELEMENT			PRESSURE PLATE		BOLT				WEIGHT FOR 10 LINK SECTION (LBS)	MIN. REQUIRED SEATING WIDTH
	ACTUAL THICKNESS (B)	FREE LENGTH (C)	AVG. LENGTH AFTER TIGHTENING (D)	(A)	(T)	ALLEN HEAD HEX ACROSS FLATS	(H)	THREAD SIZE	(L)		
LS-200-*	0.48"	1.75"	1.38"	1.06"	0.31"	4mm Allen (0.157")	4.95mm (0.195")	M5-0.8	70mm (2.755")	0.70	2.25"
LS-275-*	0.61"	1.75"	1.38"	0.97"	0.31"	4mm Allen (0.157")	4.95mm (0.195")	M5-0.8	70mm (2.755")	0.75	2.25"
LS-300-*	0.69"	2.37"	1.87"	1.56"	0.44"	6mm Allen (0.236")	7.87mm (0.310")	M8-1.25	90mm (3.543")	2.15	3.00"
LS-315-*	0.81"	2.37"	1.87"	1.44"	0.44"	6mm Allen (0.236")	7.87mm (0.310")	M8-1.25	90mm (3.543")	2.30	3.00"
LS-325-*	0.88"	2.63"	2.00"	3.13"	1.00"	13mm (0.511")	5.30mm (0.215")	M8-1.25	90mm (3.543")	5.50	4.00"
LS-340-*	1.00"	2.70"	2.25"	1.48"	0.66"	13mm (0.511")	5.30mm (0.215")	M8-1.25	120mm (4.720")	3.30	4.00"
LS-360-*	1.24"	2.70"	2.25"	2.05"	0.77"	13mm (0.511")	5.30mm (0.215")	M8-1.25	120mm (4.720")	5.10	4.00"
LS-400-*	1.38"	3.50"	2.75"	3.50"	1.06"	17mm (0.669")	6.40mm (0.250")	M10-1.5	130mm (5.118")	12.00	5.00"
LS-410-*	1.43"	3.37"	2.87"	2.52"	0.88"	17mm (0.669")	6.40mm (0.250")	M10-1.5	130mm (5.118")	8.20	5.00"
LS-425-*	1.06"	3.00"	2.25"	3.50"	1.19"	17mm (0.669")	6.40mm (0.250")	M10-1.5	130mm (5.118")	10.00	5.00"
LS-475-*	1.56"	3.38"	2.63"	2.63"	0.88"	17mm (0.669")	6.40mm (0.250")	M10-1.5	130mm (5.118")	10.00	5.00"
LS-500-*	2.25"	3.75"	2.75"	3.63"	1.06"	19mm (0.748")	7.50mm (0.300")	M12-1.75	140mm (5.511")	22.50	5.00"
LS-525-*	2.06"	3.75"	2.87"	3.63"	1.06"	19mm (0.748")	7.50mm (0.300")	M12-1.75	140mm (5.511")	21.00	5.00"
LS-575-*	1.81"	3.75"	3.00"	3.00"	1.00"	19mm (0.748")	7.50mm (0.300")	M12-1.75	140mm (5.511")	15.50	5.00"
LS-600-*	3.09"	4.00"	3.00"	6.00"	1.90"	30mm (0.748")	12.50mm (0.490")	M20-2.5	180mm (7.086")	60.60	6.00"
LS-650-*	2.71"	3.98"	3.00"	3.96"	1.19"	19mm (0.748")	7.50mm (0.300")	M12-1.75	140mm (5.511")	26.10	6.00"

Sizing Procedure - Method 1

Link-Seal® Modular Seals may be sized by using one or more methods.

Method 1 - Use the charts provided (Pages 8, 9, 10 & 11) for standard pipe sizes and types.

Link-Seal® Modular Seal Sizing Charts for Standard Pipe

How to Order: Using the Provided Sizing Charts

1. Locate charts on pages 8-11 that corresponds to the type and size pipe being used.
 2. Verify that your pipe O.D. matches the actual outside diameter shown on the chart.
 3. Determine type of wall opening (Century-Line, Steel Sleeve or Cast/Core Bit Drilled Hole).
 4. Determine Link-Seal Modular Seal model to be used (See information on page 5).
 5. To order Link-Seal Modular Seals: under the appropriate wall opening column, Link-Seal Modular Seal size (from SIZE column), Link-Seal Modular Seal model *** (C, S-316, L, LS-316, LS-S61, O, OS-316, T or FD/FS from page 5) and indicate number of links required per seal (from LINKS PER SEAL column). **[Example: LS-575-C-10]**
 6. To order corresponding sleeves indicate model number (from MODEL NUMBER column), length of sleeve and quantity required. **[Century-Line Example: CS-10-12"-1] [Steel Sleeve Example: WS-36-S-12"-1] [Cell-Cast Example: CC-32-(3")2-(4")2]**
- See Page 25 for detailed visual call-outs.

Note: Contact PSI (1-800-423-2410) or your local distributor if your pipe sizing solution is not listed in the provided charts.

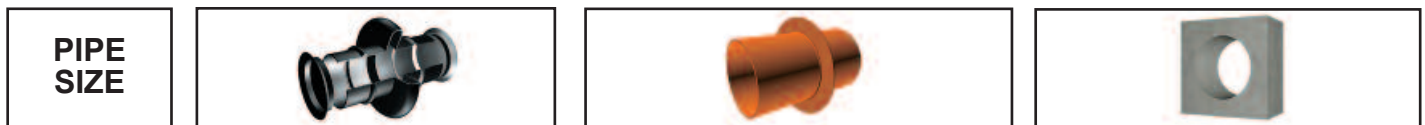

Steel and Plastic Pipe with Same Outside Diameter (IPS)

PIPE SIZE (Nom.)	ACTUAL O.D. (Inches)	CENTURY-LINE® SLEEVE			STEEL SLEEVE			CAST OR CORE BIT DRILLED HOLE		
		MODEL NUMBER	LINK-SEAL® SIZE	LINKS PER SEAL	MODEL NUMBER	LINK-SEAL® SIZE	LINKS PER SEAL	HOLE I.D.	LINK-SEAL® SIZE	LINKS PER SEAL
1/2	0.840	CS-2-*	LS-200-***	4	WS-2-15-S-*	LS-275-***	5	2.000	LS-200-***	4
3/4	1.050	CS-3-*	LS-315-***	4	WS-2-1/2-20-S-*	LS-275-***	6	3.000	LS-315-***	4
1	1.315	CS-3-*	LS-300-***	4	WS-2-1/2-20-S-*	LS-200-***	5	3.000	LS-300-***	4
1-1/4	1.660	CS-3-*	LS-275-***	7	WS-3-21-S-*	LS-275-***	8	3.000	LS-275-***	8
1-1/2	1.900	CS-3-1/2-*	LS-300-***	5	WS-3-21-S-*	LS-200-***	7	4.000	LS-315-***	6
2	2.375	CS-4-*	LS-300-***	6	WS-3-1/2-22-S-*	LS-200-***	8	4.000	LS-300-***	6
2-1/2	2.875	CS-4-*	LS-200-***	9	WS-4-23-S-*	LS-200-***	9	4.000	LS-200-***	9
3	3.500	CS-5-*	LS-300-***	8	WS-6-28-S-*	LS-360-***	7	5.000	LS-300-***	8
3-1/2	4.000	CS-6-*	LS-340-***	10	WS-6-28-S-*	LS-340-***	9	6.000	LS-315-***	10
4	4.500	CS-6-*	LS-300-***	10	WS-6-28-S-*	LS-300-***	10	6.000	LS-300-***	10
5	5.563	CS-8-*	LS-360-***	10	WS-8-32-S-*	LS-340-***	13	8.000	LS-340-***	13
6	6.625	CS-10-*	LS-475-***	10	WS-10-36-S-*	LS-475-***	10	10.000	LS-475-***	10
8	8.625	CS-12-*	LS-475-***	12	WS-12-37-S-*	LS-475-***	12	12.000	LS-475-***	12
10	10.750	CS-14-*	LS-410-***	15	WS-14-37-S-*	LS-425-***	10	14.000	LS-475-***	14
12	12.750	CS-16-*	LS-475-***	17	WS-16-37-S-*	LS-425-***	12	16.000	LS-475-***	17
14	14.000	CS-16-*	LS-340-***	30	WS-18-37-S-*	LS-475-***	18	18.000	LS-575-***	16
16	16.000	CS-20-*	LS-410-***	21	WS-20-37-S-*	LS-475-***	21	20.000	LS-575-***	18
18	18.000	CS-22-*	LS-340-***	38	WS-22-37-S-*	LS-475-***	23	22.000	LS-575-***	20
20	20.000	CS-25-*	LS-500-***	18	WS-24-37-S-*	LS-475-***	25	24.000	LS-475-***	26
22	22.000	CS-25-*	LS-360-***	34	WS-26-37-S-*	LS-475-***	28	26.000	LS-575-***	24
24	24.000	CC-30-**	LS-500-***	21	WS-28-37-S-*	LS-475-***	30	28.000	LS-475-***	31
26	26.000	CC-30-**	LS-400-***	23	WS-30-37-S-*	LS-400-***	23	30.000	LS-575-***	28
28	28.000	CC-32-**	LS-400-***	25	WS-32-37-S-*	LS-400-***	25	32.000	LS-575-***	30
30	30.000	CC-36-**	LS-500-***	26	WS-34-37-S-*	LS-400-***	27	34.000	LS-575-***	32
32	32.000	CC-38-**	LS-500-***	28	WS-36-37-S-*	LS-400-***	29	36.000	LS-575-***	34
34	34.000	CC-38-**	LS-400-***	30	WS-40-37-S-*	LS-500-***	29	38.000	LS-575-***	36
36	36.000	CC-42-**	LS-500-***	31	WS-42-37-S-*	LS-500-***	31	40.000	LS-575-***	38
42	42.000	CC-48-**	LS-500-***	36	WS-48-37-S-*	LS-500-***	36	46.000	LS-575-***	44
48	48.000	CC-54-**	LS-500-***	40	WS-53-37-S-*	LS-525-***	40	52.000	LS-575-***	50

* = Specify sleeve length in inches ** = See Cell-Cast® Page 16 *** = Specify LS Model C, S-316, L...etc when ordering (Example LS-475-C-17)
 Technically there is no limit to the pipe size that can be sealed using Link-Seal® modular seals. Please contact factory for sizes not listed and for CS model plastic sleeves for walls less than 8" thick.



Sizing Charts for Standard Pipe

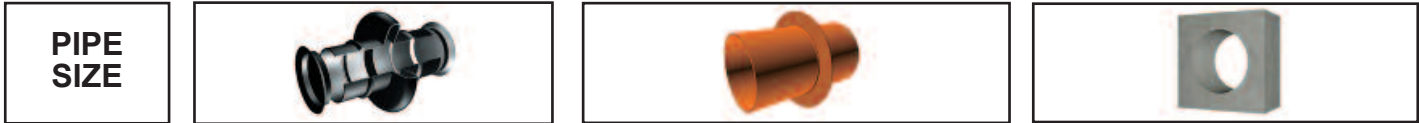

SDR-35 Gravity Sewer Pipe

PIPE SIZE (Nom.)	ACTUAL O.D. (Inches)	CENTURY-LINE® SLEEVE			STEEL SLEEVE			CAST OR CORE BIT DRILLED HOLE		
		MODEL NUMBER	LINK-SEAL® SIZE	LINKS PER SEAL	MODEL NUMBER	LINK-SEAL® SIZE	LINKS PER SEAL	HOLE I.D.	LINK-SEAL® SIZE	LINKS PER SEAL
4	4.22	CS-6-*	LS-315-***	11	WS-6-28-S-*	LS-315-***	10	6.000	LS-315-***	10
6	6.28	CS-8-*	LS-315-***	15	WS-8-32-S-*	LS-315-***	15	8.000	LS-315-***	15
8	8.40	CS-10-*	LS-325-***	9	WS-10-36-S-*	LS-315-***	19	12.000	LS-475-***	12
10	10.50	CS-14-*	LS-475-***	14	WS-14-37-S-*	LS-360-***	17	14.000	LS-475-***	14
12	12.50	CS-18-*	LS-500-***	12	WS-16-37-S-*	LS-360-***	20	16.000	LS-475-***	17
15	15.30	CS-20-*	LS-475-***	20	WS-20-37-S-*	LS-575-***	17	18.000	LS-360-***	24
18	18.70	CS-24-*	LS-575-***	21	WS-22-37-S-*	LS-360-***	29	22.000	LS-475-***	24
21	22.05	CC-30-**	LS-600-***	13	WS-26-37-S-*	LS-475-***	28	26.000	LS-575-***	24
24	24.80	CC-30-**	LS-525-***	21	WS-28-37-S-*	LS-425-***	22	28.000	LS-475-***	31
27	27.95	CC-32-**	LS-400-***	25	WS-32-37-S-*	LS-400-***	25	32.000	LS-575-***	30
30	32.00	CC-38-**	LS-500-***	28	WS-36-37-S-*	LS-400-***	29	36.000	LS-575-***	34

* = Specify sleeve length in inches ** = See Cell-Cast® Page 16 *** = Specify LS Model C, S-316, L...etc when ordering (Example LS-475-C-17)

Ductile Iron Pipe (DIPS, AWWA-C900, AWWA-C905, PVC Water Pipe)

PIPE SIZE (Nom.)	ACTUAL O.D. (Inches)	CENTURY-LINE® SLEEVE			STEEL SLEEVE			CAST OR CORE BIT DRILLED HOLE		
		MODEL NUMBER	LINK-SEAL® SIZE	LINKS PER SEAL	MODEL NUMBER	LINK-SEAL® SIZE	LINKS PER SEAL	HOLE I.D.	LINK-SEAL® SIZE	LINKS PER SEAL
2	2.500	CS-4-*	LS-300-***	6	WS-3-1/2-22-S-*	LS-200-***	8	4.000	LS-300-***	6
2-1/4	2.750	CS-4-*	LS-275-***	10	WS-4-23-S-*	LS-200-***	9	4.000	LS-200-***	9
3	3.960	CS-6-*	LS-340-***	10	WS-6-28-S-*	LS-340-***	9	6.000	LS-315-***	10
4	4.800	CS-8-*	LS-475-***	8	WS-8-32-S-*	LS-410-***	7	8.000	LS-410-***	7
6	6.900	CS-10-*	LS-475-***	10	WS-10-36-S-*	LS-410-***	10	10.000	LS-410-***	10
8	9.050	CS-12-*	LS-400-***	9	WS-12-37-S-*	LS-400-***	9	12.000	LS-400-***	9
10	11.100	CS-14-*	LS-410-***	15	WS-14-37-S-*	LS-340-***	24	14.000	LS-400-***	10
12	13.200	CS-18-*	LS-575-***	15	WS-18-37-S-*	LS-475-***	18	16.000	LS-360-***	21
14	15.300	CS-20-*	LS-475-***	20	WS-20-37-S-*	LS-575-***	17	18.000	LS-360-***	24
16	17.400	CS-22-*	LS-360-***	28	WS-22-37-S-*	LS-475-***	23	20.000	LS-360-***	27
18	19.500	CS-24-*	LS-410-***	25	WS-24-37-S-*	LS-575-***	21	24.000	LS-525-***	17
20	21.600	CS-25-*	LS-400-***	20	WS-26-37-S-*	LS-475-***	27	26.000	LS-525-***	19
24	25.800	CC-30-**	LS-400-***	23	WS-30-37-S-*	LS-400-***	23	28.000	LS-425-***	23
30	32.000	CC-38-**	LS-500-***	28	WS-36-37-S-*	LS-400-***	29	36.000	LS-575-***	34
36	38.300	CC-44-**	LS-500-***	33	WS-44-1/2-37-S-*	LS-500-***	33	42.000	LS-575-***	40
42	44.500	CC-50-**	LS-500-***	38	WS-50-37-S-*	LS-500-***	38	50.000	LS-500-***	38
48	50.800	CC-56-**	LS-500-***	43	WS-57-37-S-*	LS-500-***	43	56.000	LS-500-***	43

* = Specify sleeve length in inches ** = See Cell-Cast® Page 16 *** = Specify LS Model C, S-316, L...etc when ordering (Example LS-475-C-17)

Copper Tubing

PIPE SIZE (Nom.)	ACTUAL O.D. (Inches)	CENTURY-LINE® SLEEVE			STEEL SLEEVE			CAST OR CORE BIT DRILLED HOLE		
		MODEL NUMBER	LINK-SEAL® SIZE	LINKS PER SEAL	MODEL NUMBER	LINK-SEAL® SIZE	LINKS PER SEAL	HOLE I.D.	LINK-SEAL® SIZE	LINKS PER SEAL
1/2	0.625	CS-2-*	LS-275-***	4	WS-2-15-S-*	LS-275-***	5	2.000	LS-275-***	4
3/4	0.875	CS-2-*	LS-200-***	4	WS-2-1/2-20-S-*	LS-275-***	6	2.000	LS-200-***	4
1	1.125	CS-3-*	LS-315-***	4	WS-2-1/2-20-S-*	LS-275-***	6	3.000	LS-315-***	4
1-1/4	1.375	CS-3-*	LS-275-***	8	WS-2-1/2-20-S-*	LS-200-***	5	3.000	LS-300-***	4
1-1/2	1.625	CS-3-*	LS-275-***	8	WS-3-21-S-*	LS-275-***	7	3.000	LS-275-***	8
2	2.125	CS-4-*	LS-315-***	6	WS-3-1/2-22-S-*	LS-275-***	10	4.000	LS-315-***	6
2-1/2	2.625	CS-4-*	LS-275-***	12	WS-4-23-S-*	LS-275-***	11	4.000	LS-275-***	11
3	3.125	CS-5-*	LS-340-***	8	WS-5-25-S-*	LS-315-***	8	5.000	LS-315-***	8
4	4.125	CS-6-*	LS-315-***	11	WS-6-28-S-*	LS-315-***	10	6.000	LS-315-***	10
6	6.125	CS-8-*	LS-315-***	15	WS-8-32-S-*	LS-315-***	15	8.000	LS-315-***	15
8	8.125	CS-12-*	LS-575-***	10	WS-10-36-S-*	LS-315-***	19	12.000	LS-575-***	10
10	10.125	CS-12-*	LS-340-***	22	WS-14-37-S-*	LS-410-***	14	14.000	LS-575-***	12
12	12.125	CS-16-*	LS-575-***	14	WS-16-37-S-*	LS-410-***	16	16.000	LS-575-***	14

* = Specify sleeve length in inches *** = Specify LS Model C, S-316, L...etc when ordering (Example LS-475-C-17)

Technically there is no limit to the conduit or pipe size that can be sealed using Link-Seal® Modular Seals. Please contact factory for sizes not listed and for CS model plastic sleeves for walls less than 8" thick.



Sizing Charts for Standard Pipe



Cast Iron Soil Pipe (Extra Heavy)

PIPE SIZE (Nom.)	ACTUAL O.D. (Inches)	CENTURY-LINE® SLEEVE			STEEL SLEEVE			CAST OR CORE BIT DRILLED HOLE		
		MODEL NUMBER	LINK-SEAL® SIZE	LINKS PER SEAL	MODEL NUMBER	LINK-SEAL® SIZE	LINKS PER SEAL	HOLE I.D.	LINK-SEAL® SIZE	LINKS PER SEAL
2	2.380	CS-4*	LS-300-***	6	WS-3-1/2-22-S*	LS-200-***	8	4.000	LS-300-***	6
3	3.500	CS-5*	LS-315-***	9	WS-6-28-S*	LS-360-***	7	5.000	LS-300-***	8
4	4.500	CS-8*	LS-475-***	8	WS-6-28-S*	LS-300-***	10	6.000	LS-300-***	10
5	5.500	CS-8*	LS-360-***	10	WS-8-32-S*	LS-340-***	13	8.000	LS-340-***	13
6	6.500	CS-8*	LS-315-***	15	WS-10-36-S*	LS-475-***	10	10.000	LS-475-***	10
8	8.620	CS-12*	LS-475-***	12	WS-12-37-S*	LS-475-***	12	12.000	LS-475-***	12
10	10.750	CS-14*	LS-410-***	15	WS-14-37-S*	LS-425-***	10	14.000	LS-475-***	14
12	12.750	CS-16*	LS-475-***	17	WS-16-37-S*	LS-425-***	12	16.000	LS-475-***	17
15	15.880	CS-20*	LS-410-***	21	WS-20-37-S*	LS-475-***	20	18.000	LS-340-***	33

* = Specify sleeve length in inches *** = Specify LS Model C, S-316, L...etc when ordering (Example LS-475-C-17)

Cast Iron Soil Pipe (Service Weight)

PIPE SIZE (Nom.)	ACTUAL O.D. (Inches)	CENTURY-LINE® SLEEVE			STEEL SLEEVE			CAST OR CORE BIT DRILLED HOLE		
		MODEL NUMBER	LINK-SEAL® SIZE	LINKS PER SEAL	MODEL NUMBER	LINK-SEAL® SIZE	LINKS PER SEAL	HOLE I.D.	LINK-SEAL® SIZE	LINKS PER SEAL
2	2.300	CS-4*	LS-300-***	6	WS-4-23-S*	LS-315-***	6	4.000	LS-315-***	6
3	3.300	CS-5*	LS-300-***	8	WS-6-28-S*	LS-360-***	7	5.000	LS-300-***	8
4	4.300	CS-6*	LS-300-***	10	WS-6-28-S*	LS-315-***	10	6.000	LS-300-***	10
5	5.300	CS-8*	LS-410-***	8	WS-8-32-S*	LS-360-***	9	8.000	LS-360-***	9
6	6.300	CS-8*	LS-315-***	15	WS-8-32-S*	LS-315-***	15	8.000	LS-315-***	15
8	8.380	CS-10*	LS-325-***	9	WS-10-36-S*	LS-315-***	19	10.000	LS-315-***	19
10	10.500	CS-14*	LS-475-***	14	WS-14-37-S*	LS-360-***	17	14.000	LS-475-***	14
12	12.500	CS-18*	LS-500-***	12	WS-16-37-S*	LS-360-***	20	16.000	LS-475-***	17
15	15.620	CS-20*	LS-475-***	20	WS-20-37-S*	LS-475-***	20	18.000	LS-425-***	14

* = Specify sleeve length in inches *** = Specify LS Model C, S-316, L...etc when ordering (Example LS-475-C-17)

Electrical Metallic Tubing (EMT) Thin Wall

Conduit SIZE (Nom.)	ACTUAL O.D. (Inches)	CENTURY-LINE® SLEEVE			STEEL SLEEVE			CAST OR CORE BIT DRILLED HOLE		
		MODEL NUMBER	LINK-SEAL® SIZE	LINKS PER SEAL	MODEL NUMBER	LINK-SEAL® SIZE	LINKS PER SEAL	HOLE I.D.	LINK-SEAL® SIZE	LINKS PER SEAL
1/2	0.706	CS-2*	LS-275-***	4	WS-2-15-S*	LS-275-***	5	2.000	LS-275-***	4
3/4	0.922	CS-2*	LS-200-***	4	WS-2-1/2-20-S*	LS-275-***	6	2.000	LS-200-***	4
1	1.163	CS-3*	LS-315-***	4	WS-2-1/2-20-S*	LS-275-***	6	3.000	LS-315-***	4
1-1/4	1.510	CS-3*	LS-275-***	8	WS-3-30-S*	LS-275-***	7	3.000	LS-275-***	8
1-1/2	1.740	CS-3-1/2*	LS-300-***	5	WS-3-21-S*	LS-275-***	8	3.000	LS-200-***	6
2	2.197	CS-4*	LS-315-***	6	WS-3-1/2-22-S*	LS-275-***	10	4.000	LS-315-***	6
2-1/2	2.875	CS-4*	LS-200-***	9	WS-4-23-S*	LS-200-***	9	4.000	LS-200-***	9
3	3.500	CS-5*	LS-315-***	9	WS-6-28-S*	LS-360-***	7	5.000	LS-300-***	8
4	4.500	CS-8*	LS-475-***	8	WS-6-28-S*	LS-300-***	10	6.000	LS-300-***	10

* = Specify sleeve length in inches *** = Specify LS Model C, S-316, L...etc when ordering (Example LS-475-C-17)

Technically there is no limit to the conduit or pipe size that can be sealed using Link-Seal® modular seals.

Please contact factory for sizes not listed and for CS model plastic sleeves for walls less than 8" thick.



Sizing Charts for Standard Pipe



**PIPE
SIZE**

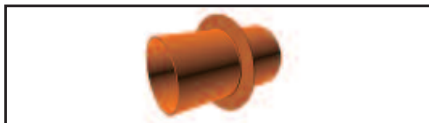

Intermediate Metal Conduit (IMC)

Conduit SIZE (Nom.)	ACTUAL O.D. (Inches)	CENTURY-LINE® SLEEVE			STEEL SLEEVE			CAST OR CORE BIT DRILLED HOLE		
		MODEL NUMBER	LINK-SEAL® SIZE	LINKS PER SEAL	MODEL NUMBER	LINK-SEAL® SIZE	LINKS PER SEAL	HOLE I.D.	LINK-SEAL® SIZE	LINKS PER SEAL
1/2	0.815	CS-2-*	LS-200-***	4	WS-2-15-S-*	LS-275-***	5	2.000	LS-200-***	4
3/4	1.029	CS-2-*	LS-200-***	4	WS-2-1/2-20-S-*	LS-275-***	6	2.000	LS-200-***	4
1	1.290	CS-3-1/2-*	LS-315-***	5	WS-2-1/2-20-S-*	LS-200-***	5	3.000	LS-300-***	4
1-1/4	1.638	CS-3-*	LS-275-***	8	WS-3-21-S-*	LS-275-***	8	3.000	LS-275-***	8
1-1/2	1.883	CS-3-1/2-*	LS-300-***	5	WS-3-21-S-*	LS-200-***	7	4.000	LS-315-***	6
2	2.360	CS-4-*	LS-300-***	6	WS-3-1/2-22-S-*	LS-200-***	8	4.000	LS-300-***	6
2-1/2	2.857	CS-4-*	LS-200-***	9	WS-4-23-S-*	LS-200-***	9	4.000	LS-200-***	9
3	3.476	CS-5-*	LS-315-***	9	WS-6-28-S-*	LS-360-***	7	5.000	LS-300-***	8
3-1/2	3.970	CS-6-*	LS-340-***	10	WS-6-28-S-*	LS-340-***	9	6.000	LS-315-***	10
4	4.466	CS-6-*	LS-315-***	11	WS-6-28-S-*	LS-300-***	10	6.000	LS-300-***	10

* = Specify sleeve length in inches *** = Specify LS Model C, S-316, L...etc when ordering (Example LS-475-C-17)

Rigid (RSC), Aluminum (ASC), Galvanized (GSC), Non-Metallic Conduit (NRC)

Conduit SIZE (Nom.)	ACTUAL O.D. (Inches)	CENTURY-LINE® SLEEVE			STEEL SLEEVE			CAST OR CORE BIT DRILLED HOLE		
		MODEL NUMBER	LINK-SEAL® SIZE	LINKS PER SEAL	MODEL NUMBER	LINK-SEAL® SIZE	LINKS PER SEAL	HOLE I.D.	LINK-SEAL® SIZE	LINKS PER SEAL
1/2	0.840	CS-2-*	LS-200-***	4	WS-2-15-S-*	LS-275-***	5	2.000	LS-200-***	4
3/4	1.050	CS-3-*	LS-315-***	4	WS-2-1/2-20-S-*	LS-275-***	6	3.000	LS-315-***	4
1	1.315	CS-3-*	LS-300-***	4	WS-2-1/2-20-S-*	LS-200-***	5	3.000	LS-300-***	4
1-1/4	1.660	CS-3-*	LS-275-***	7	WS-3-21-S-*	LS-275-***	8	3.000	LS-275-***	8
1-1/2	1.900	CS-3-1/2-*	LS-300-***	5	WS-3-21-S-*	LS-200-***	7	4.000	LS-315-***	6
2	2.375	CS-4-*	LS-300-***	6	WS-3-1/2-22-S-*	LS-200-***	8	4.000	LS-300-***	6
2-1/2	2.875	CS-4-*	LS-200-***	9	WS-4-23-S-*	LS-200-***	9	4.000	LS-200-***	9
3	3.500	CS-5-*	LS-300-***	8	WS-6-28-S-*	LS-360-***	7	5.000	LS-300-***	8
3-1/2	4.000	CS-6-*	LS-340-***	10	WS-6-28-S-*	LS-340-***	9	6.000	LS-315-***	10
4	4.500	CS-6-*	LS-300-***	10	WS-6-28-S-*	LS-300-***	10	6.000	LS-300-***	10
5	5.563	CS-8-*	LS-360-***	10	WS-8-32-S-*	LS-340-***	13	8.000	LS-340-***	13
6	6.625	CS-10-*	LS-475-***	10	WS-10-36-S-*	LS-475-***	10	10.000	LS-475-***	10

* = Specify sleeve length in inches *** = Specify LS Model C, S-316, L...etc when ordering (Example LS-475-C-17)

Technically there is no limit to the conduit or pipe size that can be sealed using Link-Seal® modular seals.

Please contact factory for sizes not listed and for CS model plastic sleeves for walls less than 8" thick.



Sizing Procedure - Method 2

Method 2 - Link-Seal® Modular Seal Sizing

If your pipe size does not appear in the charts on pages 8,9, 10 & 11, use the following method to select the correct Link-Seal® modular seal for your application.

1. Calculate the annular space. The annular space is half the difference between the actual pipe O.D. and the actual wall I.D. opening diameter. Use the following formula.

$$\text{Annular Space} = \frac{\text{Wall Opening I.D.} - \text{Actual Pipe O.D.}}{2}$$

2. From the adjacent chart, select the size closest to the annular space calculated in step 1. You have selected the correct size Link-Seal® modular seal if...the free state thickness is less than the annular space...and the expanded state thickness is greater than the annular space.

3. Calculate the number of links required to fit around the pipe and seal the annular space.

A. Determine the bolt circle for your Link-Seal® modular seal assembly by using the following formula.

$$\text{Bolt Circle} = \frac{\text{Wall Opening I.D.} + \text{Pipe Diameter O.D.}}{2}$$

B. Find the Link-Seal® modular seal chord length (Column 4) and use the following formula to determine required number of links per Link-Seal® modular seal assembly.

$$\text{Links Per Seal} = \frac{\text{Bolt Circle} \times 3.14}{\text{Chord Length}}$$

The result must be **rounded down** to the next whole number. The figures are accurate if the calculation results in **13** or more links per belt. If the results are fewer than 13 links verify using the tables on pages 13 and 14.

Example

Wall Opening I.D. = 12"
Actual Pipe O.D. = 9.05"

$$\text{Annular Space} = \frac{12 - 9.05}{2} = 1.475$$

Calculate the annular space (1.475"). Select the Link-Seal® modular seal size closest to the annular space. LS-400 is chosen from the chart, because 1.475" falls between 1.43 & 1.81 (the free state and expanded state thickness.)

Determine the number of links for a complete assembly.

$$\text{Bolt Circle} = \frac{12 + 9.05}{2} = 10.525$$

Chord Length for LS-400 = 3.625"

$$\text{Links Per Seal} = \frac{10.525 \times 3.14}{3.625} = 9.12$$

Links Per Seal = 9.12, rounded down = 9

Since the final calculation results in fewer than 13 links, it is advisable to verify the accuracy of the calculation by using the verification tables on pages 13 and 14.

Link-Seal Model Selected for Penetration	Minimum Required Seating Width
LS-200/275	2.25"
LS-300/315	3.00"
LS-325/340/360	4.00"
LS-400/410/425/475	5.00"
LS-500/525/575	5.00"
LS-600/650	6.00"

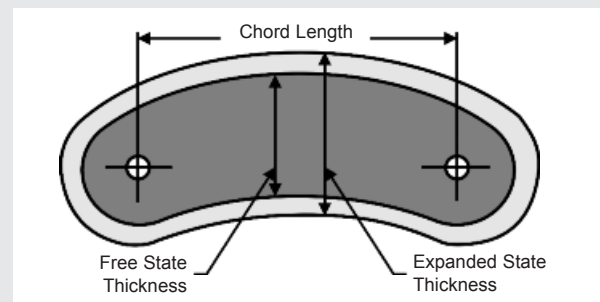

LINK-SEAL SIZE	FREE STATE THICKNESS	EXPANDED STATE THICKNESS	CHORD LENGTH
LS-200	0.50"	0.64"	1.120"
LS-275	0.62"	0.80"	0.906"
LS-300	0.71"	0.92"	1.510"
LS-315	0.82"	1.10"	1.469"
LS-325	0.94"	1.14"	3.110"
LS-340	1.05"	1.33"	1.575"
LS-360	1.29"	1.65"	2.106"
LS-400	1.43"	1.87"	3.622"
LS-410	1.48"	1.91"	2.598"
LS-425	1.13"	1.43"	3.622"
LS-475	1.62"	2.08"	2.630"
LS-500	2.37"	2.81"	3.860"
LS-525	2.18"	2.58"	3.860"
LS-575	1.88"	2.35"	3.100"
LS-600	3.20"	4.00"	6.000"
LS-650	2.76"	3.57"	4.16"

* = Free state thickness includes an insertion tolerance, and therefore, differs from the actual thickness as listed in Link-Seal modular seal dimensional data on page 6.

Suggested Pipe O.D. Range

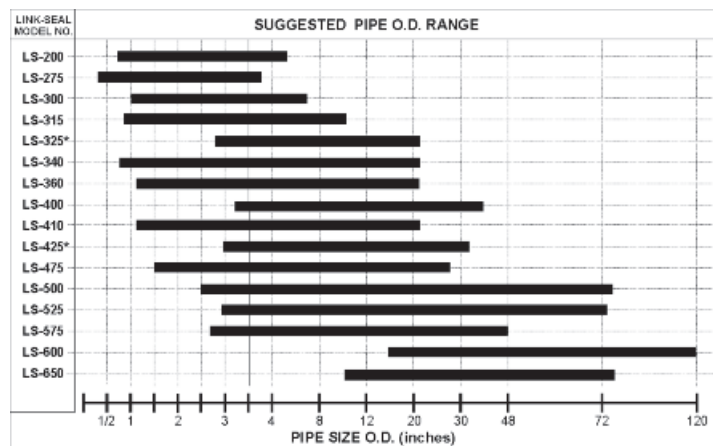

* = Whenever possible use thicker links, such as the LS-400, LS-475 or LS-500 series to provide more leeway.

Calculations using Link-Seal modular seal sizing Method 2 may indicate that a smaller link may be used when compared to data on the above chart. NOTE: This chart is based on using an average of two pipe size differential opening.



Sizing Procedure- Method 2 (Verification)

Verification - Link-Seal® Modular Seal Sizing

The following charts will allow you to confirm the accuracy of this information.

1. Refer to the chart for the Link-Seal® modular seal size calculated in Sizing Procedure - Method 2. (LS-200, LS-300 etc.)
2. Find the range your pipe O.D. falls within. (It may fall in either Range #1 or Range #2).

You now have minimum and maximum wall opening dimensions. If your wall opening size falls between these dimensions, your Link-Seal® modular seal size is correct. You may also verify the number of links from column 6. If your wall opening size is not in the range indicated by the chart, either choose another Link-Seal® modular seal size, change your wall opening size or call PSI for assistance: 1-800-423-2410

Example:

Link-Seal® Size = LS-300
Actual Pipe O.D. = 2.900

2.900 falls within Range #2 on LS-300 Chart.

Determine Minimum Wall Opening = 2.900 + 1.408 (from col. 4)

$$\text{Minimum Wall Opening} = 2.900 + 1.408 = 4.308$$

Determine Maximum Wall Opening = 2.900 + 1.831 (from col. 5)

$$\text{Maximum Wall Opening} = 2.900 + 1.831 = 4.731$$

$$\text{Number of Links} = 7 \text{ (from col. 6)}$$

Link-Seal® LS-200 Verification Chart

Range #1 Pipe O.D. Min. - Max.	Range #2 Pipe O.D. Min. - Max.	for Range #1 Minimum Wall Opening	for Range #2 Pipe O.D. plus Number Below = Min. Wall Opening	for Range #1 & 2 Pipe O.D. plus Number Below = Max. Wall Opening	No. Links/ Seal
0.757-0.909	0.909-1.084	2.033	1.124	1.277	4
1.072-1.323	1.323-1.475	2.349	1.026	1.277	5
1.400-1.713	1.713-1.862	2.677	0.964	1.277	6
1.775-2.051	2.051-2.208	3.052	1.000	1.277	7
2.146-2.390	2.390-2.563	3.422	1.032	1.277	8
2.512-2.731	2.731-2.925	3.789	1.057	1.277	9
2.874-3.074	3.074-3.291	4.151	1.077	1.277	10
3.235-3.419	3.419-3.658	4.511	1.093	1.277	11
3.593-3.764	3.764-4.027	4.870	1.106	1.277	12

Link-Seal® LS-275 Verification Chart

Range #1 Pipe O.D. Min. - Max.	Range #2 Pipe O.D. Min. - Max.	for Range #1 Minimum Wall Opening	for Range #2 Pipe O.D. plus Number Below = Min. Wall Opening	for Range #1 & 2 Pipe O.D. plus Number Below = Max. Wall Opening	No. Links/ Seal
0.194-0.554	0.554-0.797	1.786	1.231	1.592	4
0.475-0.828	0.828-1.190	2.067	1.239	1.592	5
0.773-1.079	1.079-1.550	2.365	1.286	1.592	6
1.062-1.334	1.334-1.917	2.654	1.320	1.592	7
1.345-1.593	1.593-2.289	2.937	1.344	1.592	8
1.625-1.853	1.853-2.663	3.216	1.363	1.592	9
1.901-2.115	2.115-3.039	3.493	1.378	1.592	10
2.176-2.378	2.378-3.417	3.768	1.391	1.592	11
2.450-2.641	2.641-3.795	4.042	1.401	1.592	12

Link-Seal® LS-300 Verification Chart

Range #1 Pipe O.D. Min. - Max.	Range #2 Pipe O.D. Min. - Max.	for Range #1 Minimum Wall Opening	for Range #2 Pipe O.D. plus Number Below = Min. Wall Opening	for Range #1 & 2 Pipe O.D. plus Number Below = Max. Wall Opening	No. Links/ Seal
1.018-1.278	1.278-1.415	2.849	1.571	1.831	4
1.460-1.857	1.857-2.024	3.291	1.434	1.831	5
1.919-2.404	2.404-2.605	3.750	1.346	1.831	6
2.449-2.873	2.873-3.107	4.280	1.408	1.831	7
2.969-3.347	3.347-3.617	4.800	1.453	1.831	8
3.482-3.825	3.825-4.132	5.313	1.487	1.831	9
3.990-4.306	4.306-4.650	5.821	1.515	1.831	10
4.494-4.788	4.788-5.171	6.325	1.538	1.831	11
4.996-5.271	5.271-5.693	6.828	1.556	1.831	12

Link-Seal® LS-315 Verification Chart

Range #1 Pipe O.D. Min. - Max.	Range #2 Pipe O.D. Min. - Max.	for Range #1 Minimum Wall Opening	for Range #2 Pipe O.D. plus Number Below = Min. Wall Opening	for Range #1 & 2 Pipe O.D. plus Number Below = Max. Wall Opening	No. Links/ Seal
0.665-0.982	0.982-1.208	2.860	1.878	2.195	4
1.082-1.530	1.530-1.795	3.278	1.748	2.195	5
1.517-2.047	2.047-2.359	3.712	1.665	2.195	6
1.961-2.549	2.549-2.917	4.156	1.607	2.195	7
2.448-3.003	3.003-3.428	4.643	1.640	2.195	8
2.933-3.455	3.455-3.941	5.128	1.673	2.195	9
3.413-3.909	3.909-4.458	5.609	1.699	2.195	10
3.891-4.366	4.366-4.977	6.086	1.720	2.195	11
4.366-4.823	4.823-5.498	6.561	1.738	2.195	12

Link-Seal® LS-325 Verification Chart

Range #1 Pipe O.D. Min. - Max.	Range #2 Pipe O.D. Min. - Max.	for Range #1 Minimum Wall Opening	for Range #2 Pipe O.D. plus Number Below = Min. Wall Opening	for Range #1 & 2 Pipe O.D. plus Number Below = Max. Wall Opening	No. Links/ Seal
2.593-2.593	2.593-2.775	5.214	2.272	2.272	4
3.748-3.748	3.748-4.010	6.095	2.272	2.272	5
4.739-4.839	4.839-5.178	7.012	2.172	2.272	6
5.675-5.896	5.896-6.309	7.947	2.051	2.272	7
6.621-6.933	6.933-7.418	8.893	1.961	2.272	8
7.574-7.955	7.955-8.512	9.846	1.891	2.272	9
8.532-8.968	8.968-9.596	10.805	1.836	2.272	10
9.494-9.975	9.975-10.673	11.766	1.791	2.272	11
10.458-10.976	10.976-11.744	12.730	1.754	2.272	12

Link-Seal® LS-340 Verification Chart

Range #1 Pipe O.D. Min. - Max.	Range #2 Pipe O.D. Min. - Max.	for Range #1 Minimum Wall Opening	for Range #2 Pipe O.D. plus Number Below = Min. Wall Opening	for Range #1 & 2 Pipe O.D. plus Number Below = Max. Wall Opening	No. Links/ Seal
0.544-0.914	0.914-1.032	3.204	2.290	2.660	4
0.992-1.501	1.501-1.695	3.652	2.151	2.660	5
1.457-2.055	2.055-2.320	4.117	2.062	2.660	6
1.932-2.592	2.592-2.927	4.592	2.000	2.660	7
2.458-3.073	3.073-3.469	5.118	2.046	2.660	8
2.978-3.557	3.557-4.016	5.638	2.081	2.660	9
3.493-4.004	4.004-4.565	6.153	2.109	2.660	10
4.004-4.532	4.532-5.117	6.664	2.132	2.660	11
4.512-5.022	5.022-5.670	7.172	2.151	2.660	12

Link-Seal® LS-360 Verification Chart

Range #1 Pipe O.D. Min. - Max.	Range #2 Pipe O.D. Min. - Max.	for Range #1 Minimum Wall Opening	for Range #2 Pipe O.D. plus Number Below = Min. Wall Opening	for Range #1 & 2 Pipe O.D. plus Number Below = Max. Wall Opening	No. Links/ Seal
0.901-1.269	1.269-1.430	4.200	2.931	3.299	4
1.502-2.056	2.056-2.318	4.800	2.744	3.299	5
2.127-2.801	2.801-3.156	5.426	2.625	3.299	6
2.765-3.522	3.522-3.969	6.063	2.542	3.299	7
3.410-4.228	4.228-4.765	6.709	2.480	3.299	8
4.107-4.879	4.879-5.498	7.406	2.528	3.299	9
4.798-5.532	5.532-6.235	8.097	2.565	3.299	10
5.485-6.188	6.188-6.974	8.784	2.596	3.299	11
6.168-6.845	6.845-7.715	9.467	2.621	3.299	12





Sizing Procedure- Method 2 (Verification)

Link-Seal® LS-400 Verification Chart

Range #1 Pipe O.D. Min. - Max.	Range #2 Pipe O.D. Min. - Max.	for Range #1 Minimum Wall Opening	for Range #2 Pipe O.D. plus Number Below = Min. Wall Opening	for Range #1 & 2 Pipe O.D. plus Number Below = Max. Wall Opening	No. Links/ Seal
2.711-2.711	2.711-3.350	6.490	3.748	3.748	4
3.779-4.071	4.071-4.920	7.527	3.456	3.748	5
4.858-5.356	5.356-6.267	8.606	3.250	3.748	6
5.960-6.601	6.601-7.671	9.708	3.107	3.748	7
7.074-7.821	7.821-8.938	10.822	3.001	3.748	8
8.196-9.025	9.025-10.163	11.944	2.919	3.748	9
9.325-10.218	10.218-11.363	13.073	2.854	3.748	10
10.457-11.403	11.403-12.549	14.205	2.802	3.748	11
11.593-12.583	12.583-13.735	15.341	2.758	3.748	12

Link-Seal® LS-410 Verification Chart

Range #1 Pipe O.D. Min. - Max.	Range #2 Pipe O.D. Min. - Max.	for Range #1 Minimum Wall Opening	for Range #2 Pipe O.D. plus Number Below = Min. Wall Opening	for Range #1 & 2 Pipe O.D. plus Number Below = Max. Wall Opening	No. Links/ Seal
1.288-1.677	1.677-1.888	5.110	3.433	3.822	4
2.034-2.655	2.655-2.989	5.856	3.201	3.822	5
2.809-3.579	3.579-4.029	6.632	3.053	3.822	6
3.601-4.473	4.473-5.037	7.423	2.950	3.822	7
4.402-5.350	5.350-6.025	8.224	2.874	3.822	8
5.268-6.157	6.157-6.933	9.090	2.933	3.822	9
6.125-6.968	6.968-7.846	9.948	2.979	3.822	10
6.977-7.782	7.782-8.763	10.800	3.017	3.822	11
7.825-8.599	8.599-9.682	11.647	3.049	3.822	12

Link-Seal® LS-425 Verification Chart

Range #1 Pipe O.D. Min. - Max.	Range #2 Pipe O.D. Min. - Max.	for Range #1 Minimum Wall Opening	for Range #2 Pipe O.D. plus Number Below = Min. Wall Opening	for Range #1 & 2 Pipe O.D. plus Number Below = Max. Wall Opening	No. Links/ Seal
3.039-3.039	3.039-3.312	6.186	2.867	2.867	4
4.360-4.403	4.403-4.799	7.227	2.824	2.867	5
5.442-5.691	5.691-6.204	8.309	2.618	2.867	6
6.546-6.940	6.940-7.564	9.413	2.474	2.867	7
7.664-8.163	8.163-8.898	10.531	2.367	2.867	8
8.790-9.371	9.371-10.214	11.656	2.286	2.867	9
9.921-10.567	10.567-11.519	12.788	2.220	2.867	10
11.057-11.756	11.756-12.814	13.924	2.168	2.867	11
12.195-12.939	12.939-14.103	15.062	2.124	2.867	12

Link-Seal® LS-475 Verification Chart

Range #1 Pipe O.D. Min. - Max.	Range #2 Pipe O.D. Min. - Max.	for Range #1 Minimum Wall Opening	for Range #2 Pipe O.D. plus Number Below = Min. Wall Opening	for Range #1 & 2 Pipe O.D. plus Number Below = Max. Wall Opening	No. Links/ Seal
1.017-1.490	1.490-1.773	5.174	3.685	4.158	4
1.750-2.451	2.451-2.754	5.907	3.457	4.158	5
2.512-3.359	3.359-3.692	6.670	3.311	4.158	6
3.291-4.238	4.238-4.621	7.448	3.210	4.158	7
4.078-5.101	5.101-5.544	8.236	3.135	4.158	8
4.920-5.903	5.903-6.493	9.078	3.175	4.158	9
5.763-6.700	6.700-7.272	9.921	3.221	4.158	10
6.601-7.501	7.501-8.139	10.758	3.258	4.158	11
7.434-8.303	8.303-9.009	11.592	3.289	4.158	12

Link-Seal® LS-500 Verification Chart

Range #1 Pipe O.D. Min. - Max.	Range #2 Pipe O.D. Min. - Max.	for Range #1 Minimum Wall Opening	for Range #2 Pipe O.D. plus Number Below = Min. Wall Opening	for Range #1 & 2 Pipe O.D. plus Number Below = Max. Wall Opening	No. Links/ Seal
2.065-2.065	2.065-2.271	7.778	5.625	5.625	4
3.249-3.503	3.503-3.853	8.874	5.372	5.625	5
4.391-4.861	4.861-5.347	10.016	5.154	5.625	6
5.555-6.177	6.177-6.795	11.180	5.003	5.625	7
6.733-7.467	7.467-8.214	12.358	4.890	5.625	8
7.920-8.740	8.740-9.614	13.545	4.804	5.625	9
9.113-10.002	10.002-11.002	14.738	4.736	5.625	10
10.310-11.255	11.255-12.380	15.935	4.680	5.625	11
11.510-12.502	12.502-13.752	17.135	4.634	5.625	12

Link-Seal® LS-525 Verification Chart

Range #1 Pipe O.D. Min. - Max.	Range #2 Pipe O.D. Min. - Max.	for Range #1 Minimum Wall Opening	for Range #2 Pipe O.D. plus Number Below = Min. Wall Opening	for Range #1 & 2 Pipe O.D. plus Number Below = Max. Wall Opening	No. Links/ Seal
2.330-2.330	2.330-2.565	7.676	5.156	5.156	4
3.634-3.791	3.791-4.337	8.791	5.000	5.156	5
4.794-5.172	5.172-6.002	9.950	4.779	5.156	6
5.977-6.509	6.509-7.555	11.133	4.625	5.156	7
7.174-7.819	7.819-9.003	12.330	4.511	5.156	8
8.379-9.113	9.113-10.364	13.536	4.423	5.156	9
9.592-10.395	10.395-11.642	14.748	4.353	5.156	10
10.808-11.668	11.668-12.817	15.965	4.297	5.156	11
12.028-12.935	12.935-13.825	17.184	4.250	5.156	12

Link-Seal® LS-575 Verification Chart

Range #1 Pipe O.D. Min. - Max.	Range #2 Pipe O.D. Min. - Max.	for Range #1 Minimum Wall Opening	for Range #2 Pipe O.D. plus Number Below = Min. Wall Opening	for Range #1 & 2 Pipe O.D. plus Number Below = Max. Wall Opening	No. Links/ Seal
1.554-1.698	1.698-1.911	6.259	4.561	4.706	4
2.444-2.865	2.865-3.124	7.149	4.284	4.706	5
3.370-3.968	3.968-4.275	8.075	4.108	4.706	6
4.314-5.036	5.036-5.402	9.020	3.984	4.706	7
5.270-6.082	6.082-6.514	9.976	3.894	4.706	8
6.233-7.116	7.116-7.616	10.939	3.824	4.706	9
7.201-8.139	8.139-8.710	11.907	3.768	4.706	10
8.173-9.156	9.156-9.797	12.879	3.723	4.706	11
9.147-10.168	10.168-10.880	13.853	3.685	4.706	12

Link-Seal® LS-600 Verification Chart

Range #1 Pipe O.D. Min. - Max.	Range #2 Pipe O.D. Min. - Max.	for Range #1 Minimum Wall Opening	for Range #2 Pipe O.D. plus Number Below = Min. Wall Opening	for Range #1 & 2 Pipe O.D. plus Number Below = Max. Wall Opening	No. Links/ Seal
8.358-8.358	8.358-8.784	16.334	7.416	7.416	6
10.210-10.425	10.425-10.956	17.626	7.202	7.416	7
11.605-12.450	12.450-13.085	19.021	6.571	7.416	8
13.214-14.450	14.450-15.187	20.630	6.181	7.416	9
15.194-16.323	16.323-17.155	22.611	6.288	7.416	10
17.162-18.203	18.203-19.131	24.578	6.376	7.416	11
19.120-20.088	20.088-21.113	26.536	6.448	7.416	12

Link-Seal® LS-650 Verification Chart

Range #1 Pipe O.D. Min. - Max.	Range #2 Pipe O.D. Min. - Max.	for Range #1 Minimum Wall Opening	for Range #2 Pipe O.D. plus Number Below = Min. Wall Opening	for Range #1 & 2 Pipe O.D. plus Number Below = Max. Wall Opening	No. Links/ Seal
3.882 - 4.968	4.968 - 5.221	11.032	6.064	6.670	6
5.144 - 6.394	6.394 - 6.720	12.294	5.900	6.670	7
6.421 - 7.793	7.793 - 8.190	13.571	5.778	6.670	8
7.708 - 9.173	9.173 - 9.641	14.858	5.685	6.670	9
9.001 - 10.154	10.154 - 11.078	16.151	5.997	6.670	10
10.299 - 11.898	11.898 - 12.505	17.449	5.551	6.670	11
11.600 - 13.250	13.250 - 13.926	18.750	5.500	6.670	12





Century-Line® Engineered Sleeves

Century-Line® Sleeves

are used to create circular holes in concrete poured barriers of all types including; walls, floors and ceilings. Molded from non-conductive, high impact resistant HDPE, Century-Line® sleeves are lightweight and easily installed by one construction worker without use of cranes or hoists. They are available in 16 diameters ranging from 2" to 25" (51mm - 635mm) and shipped, from stock, in any desired length.

Weight Comparison	
WS Steel Sleeve WS-12-37-S-12 = 60 lbs.	Century-Line Sleeve CS-12-12 = 6.5 lbs

Features

16 sizes - 2" to 25" in diameter. Local stock, drop ship overnight.

In the event of a field or engineering change, sleeves may be cut shorter at the job site using ordinary hand tools. Standard sleeves are 16" (406mm) in length. Longer length models may also be quickly fabricated as a custom ordered item.

1/8 the weight of steel.

Century-Line® sleeves are light enough for one worker to install without a crane, hoist or helper which reduces installation time and costs. Century-Line® sleeves are easy to stock and far less expensive to ship, when compared to steel sleeves.

Resists water migration.

The 2" (50.8mm) water stop collar not only anchors the sleeve in position but creates a path against the migration of water around the outside of the sleeve.

Adjusts to wall thickness.

Century-Line sleeves' unique hollow water stop collar acts like an expansion joint, adjusting (up to 1/2" - 12.7mm) to the thickness of the wall. This compressive force reacts against the forms like a spring, creating pressure and maintains proper sleeve location within the form.

Nailer end caps position sleeve precisely in form.

Specially designed end caps provide an ideal method for attaching Century-Line® sleeves to the concrete forms. The end caps assure that the sleeve holds its circular configuration during the pour. In addition to keeping out wet concrete, they also prevent dirt from entering the sleeve during backfill operations or the interim construction period.

Tough high density polyethylene (HDPE) construction.

High impact resistant HDPE also provides excellent resistance to acids, alkalis and other organic solvents. Ideal for cathodic protection systems, these non-conductive sleeves will neither rust, corrode or degrade. Low-temperature properties are such that they may be installed under any weather conditions suitable for pouring concrete. High temperature application limit is 150° F. (66° C.). The sleeve is molded with a texture on the outside surface to assure a better bond than most plastic to concrete interfaces.

Used for shotcrete wall applications.

For shotcrete applications, Century-Line sleeves are easily positioned to wall form with threaded rod, and the end caps protect the sleeve penetration while the wall is formed.

How To Order

Please see page 25 for ordering information on Link-Seal® modular seals and Century-Line® sleeves.

Weights and Dimensional Data Model CS (16" length)

MODEL	I.D. (In.)	I.D. (mm)	O.D. (In.)	lbs.	Kg.
CS-2	1.97	50.04	2.13	0.70	0.32
CS-3	2.88	73.15	3.19	1.30	0.59
CS-3-1/2	3.31	84.07	3.63	1.50	0.68
CS-4	4.00	101.60	4.38	2.00	0.90
CS-5	5.13	130.30	5.50	2.80	1.27
CS-6	6.13	155.70	6.50	3.60	1.63
CS-8	8.25	209.55	8.63	4.80	2.18
CS-10	10.25	260.35	10.63	6.40	2.90
CS-12	12.25	311.15	12.63	7.20	3.27
CS-14	14.19	360.43	14.69	11.20	5.08
CS-16	16.25	412.75	16.75	12.00	5.44
CS-18	17.50	444.50	18.00	15.50	7.03
CS-20	19.13	485.90	19.63	17.50	7.94
CS-22	20.75	527.05	21.25	21.00	9.53
CS-24	22.75	577.85	23.25	22.00	9.98
CS-25	24.75	628.65	25.25	23.00	10.43

Note: Swimming pool, floor, and shotcrete applications; please specify exact lengths when ordering. Typically, a form is not installed on the top of a pool or floor, the CS sleeve water stop will not compress in these applications.

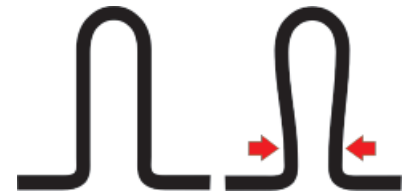
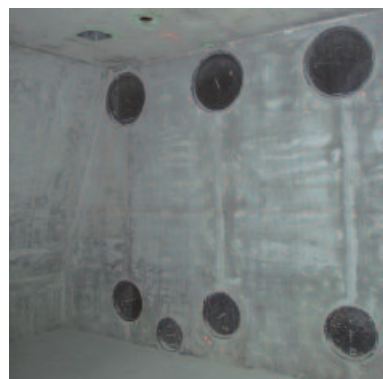
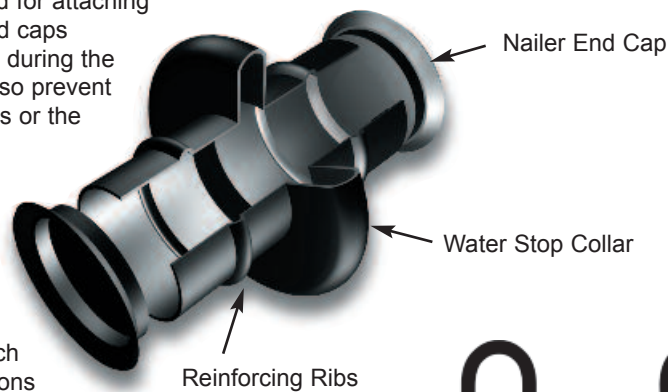

Adjusts To Wall Thickness

Century-Line sleeves unique hollow water stop collar works like an expansion joint, adjusting (up to 1/2") to the thickness of wall. This design creates a dynamic force against the form.

Nesting of Sleeves

Allow for a 2" minimum clearance between wall sleeves/water-stop collars for concrete pour.





Cell-Cast® Interlocking Hole Forming Disks



Cell-Cast® Interlocking Hole Forming Disks are designed to produce large diameter holes in poured concrete structures. Molded from non-conductive plastic, Cell-Cast® disks are lightweight and may be installed by one construction worker. They are available in a wide range of diameters using 3" and 4" thick modular disks.

Weight Comparison Keep the contractor in mind!

WS Steel Sleeve
WS-48-37-2-12 = 250 lbs.

Cell-Cast Disks
CC-48-4(3) = 62 lbs.

Features

Economy

- Reduces material costs by 30 to 50%.
- Cuts labor costs by 50 - 70%.
- Minimizes freight and handling charges.

Quality

- Consistently produces dimensionally accurate openings.
- Eliminates galvanic corrosion.
- Avoids potential leak path between sleeve and concrete.

Installation

- Lightweight - 1/8 the weight of steel pipe sleeves.
- Complete assembly accomplished in minutes.
- Easily installed by one construction worker.

Availability

- Cell-Cast® Disks are stocked in a variety of diameters up to 64.75" (164cm) and available for immediate delivery.
- Larger sizes are available by special order.

How to Size

- Cell-Cast® Disks are produced in 3" and 4" thicknesses and can be assembled to fit virtually any wall. For example:
- Combine two 3" cells and one 4" cell for 10" walls.
- Combine two 4" cells and one 3" cell for 11" walls.
- Combine three 4" cells for 12" walls.

Cell-Cast® Hole Forming Disks

CELL-CAST® MODEL NO.	HOLE I.D.	3" THICKNESS		4" THICKNESS	
		LBS	KG	LBS	KG
CC-30	29.25	10.0	4.53	10.4	4.71
CC-32	31.13	10.8	4.89	11.2	5.08
CC-36	34.75	12.6	5.71	13.1	5.94
CC-38	37.25	13.9	6.30	14.4	6.53
CC-42	41.38	16.3	7.39	16.8	7.62
CC-44	43.75	17.7	8.02	18.3	8.30
CC-48	47.25	20.0	9.07	20.7	9.38
CC-50	50.00	22.0	9.97	22.6	10.25
CC-54	52.63	23.9	10.84	24.6	11.15
CC-56	56.00	26.5	12.02	27.3	12.38
CC-60	59.25	29.2	13.24	30.0	13.60
CC-64	62.75	32.2	14.60	33.1	15.01
CC-66	64.75	34.0	15.42	34.9	15.83

Note: For walls greater than 16", please contact PSI at 1-800-423-2410.

Please see pages 8, 9, 10 and 11 for standard size pipe and Cell-Cast® Disk ordering code page 25. Threaded rod must be requested when ordering. Specify TRA at the end of the ordering code.

Typical Wall Opening Specification

A. Century-Line® Sleeves - for openings to 24.81" diameter.

Where pipes must pass through walls and floors of new structures, unless otherwise shown or specified, install molded non-metallic high density polyethylene Model CS Century-Line® sleeves as manufactured by PSI-Thunderline/Link-Seal®. Model CS sleeves shall have integrally formed hollow water stop sized having a minimum of four inches larger than the outside diameter of the sleeve itself and allowing 1/2" movement between wall forms to resist pour forces. Each sleeve assembly shall have end caps manufactured of the same material as the sleeve itself and installed at each end of the sleeve so as to prevent deformation during the initial concrete pour, and to facilitate attaching the sleeve to the wall forms. End caps shall remain in place to protect the opening from residual debris and rodent entry prior to pipe insertion.

B. Cell-Cast® Disks - for openings from 29.25" to 64.74" diameter.

The contractor shall install Cell-Cast® disks, providing a round hole in conformance with Link-Seal® modular seal sizing data. Cell-Cast® disks shall consist of 3" and/or 4" lightweight interlocking polyethylene cells stacked to form the thickness of the poured concrete wall. Molded into each cell shall be a cavity to accept a 2" x 4" nailer.



WS Steel Wall Sleeves

WS Wall Sleeves are constructed from steel and available in a wide range of diameters and lengths. They are an excellent choice for installations where the Link-Seal® Modular Seal and WS sleeve assembly would be subject to extremely high temperatures or where fire seals are specified.

Continuous Weld-Bead on both sides.

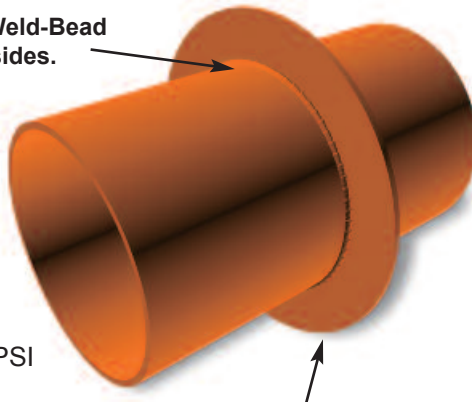

2" Steel Water Stop

How To Order

Please see Page 25 for ordering information on Link-Seal® modular seals and WS Steel Sleeves. For diameters larger than 24", contact PSI at 1-800-423-2410

WS Steel Wall Sleeve Specification

Provide WS Steel sleeves for all pipes passing through concrete or masonry structures. The WS Sleeves shall be provided free of welding slag. WS Steel Sleeve sizes through 10" shall be Schedule 40 Steel Pipe or standard wall thickness. WS Steel Sleeve sizes 12" and larger shall have a .375" or standard wall thickness. WS Sleeves through wall shall be cast in place and the pipe shall be installed centered in sleeve. The 2" collar, (water-stop) shall be the same type of steel as the WS sleeve. The collar shall be welded all around on both sides to the

Model WS (12" length)

MODEL	I.D.	lbs.	Kg.
WS-2-15-S-12	2.07	5.53	2.51
WS-2-1/2-20-S-12	2.47	7.91	3.58
WS-3-21-S-12	3.07	9.93	4.51
WS-3-1/2-22-S-12	3.55	11.70	5.31
WS-4-23-S-12	4.03	13.61	6.17
WS-5-25-S-12	5.05	17.91	8.12
WS-6-28-S-12	6.07	22.73	10.31
ws-6-18-S-12	6.25	14.82	6.72
WS-8-32-S-12	7.98	33.55	15.22
ws-8-18-S-12	8.25	21.94	9.95
WS-10-36-S-12	10.02	46.12	20.92
ws-10-25-S-12	10.25	33.67	15.27
WS-12-37-S-12	12.00	60.14	27.28
WS-14-37-S-12	13.25	62.04	28.14
WS-16-37-S-12	15.25	71.04	32.22
WS-18-37-S-12	17.25	79.98	36.28
WS-20-37-S-12	19.25	90.00	40.82
WS-22-37-S-12	21.25	98.00	44.45
WS-24-37-S-12	23.25	107.00	48.53

Note: ws rolled sleeves (6" & 8") = .1875" wall thickness; (10") = .25" wall thickness. Intermediate sleeves available, model information on-line in a pdf file.

sleeve at the point on the sleeve that positions it at the mid-point of the structural wall when the sleeve is in place. The WS Steel Sleeve w/water-stop shall be primed inside and outside with Sherwin Williams Water Base Red Primer or approved equivalent.

Pipeline Seal and Insulator, Inc., Houston, Texas, U.S.A shall provide WS Steel Sleeves.

Visit www.linkseal.com for more WS Steel Sleeve Types

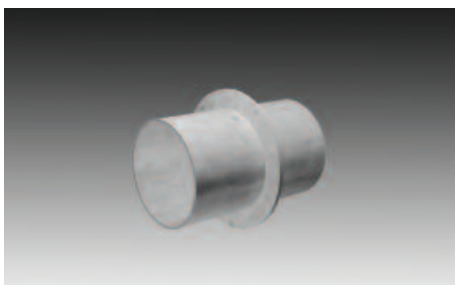

Model WS Painted and Galvanized Steel Wall Sleeves are an excellent choice for installations where the Link-Seal® Modular Seal and WS sleeve assembly would be subject to extremely high temperatures or where fire seals are specified

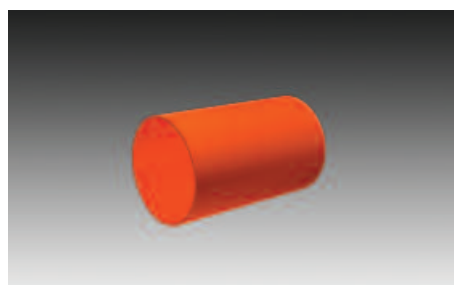

WS Intermediate Sleeves are used in conjunction with Link-Seal® Modular Seals to seal all pipes passing through concrete or masonry structures that require two belts of seals to fill the annular space between pipe and wall. Please see page 21, sealing an oversize annulus.

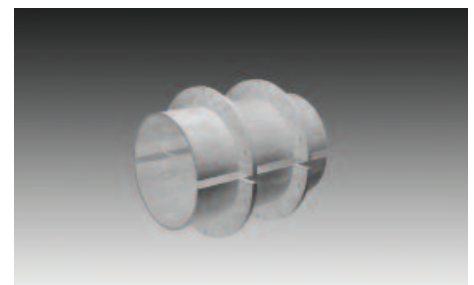

Model WS Split Sleeves are used for installations where an existing pipe run needs to penetrate a wall yet to be constructed. During wall installation a split sleeve is welded around the existing pipe and positioned in the form to center the pipe. After installation a Link-Seal® Modular Seal is used to seal the annular space between split sleeve and pipe.



Steel Pipe Reference Schedules

Wall Thickness Chart For: Black Steel, API, IPS, RSC

The following wall thickness chart has been provided to help size Link-Seal® modular seals in steel pipe sleeves of various wall thicknesses. To determine the Inside Diameter (I.D.) of the proposed steel wall sleeve subtract **2 times** the selected Wall Thickness (W.T.) from the actual Outside Diameter (O.D.) of the pipe.

Example: Find the I.D. for a 5" (INCH) Schedule 40 Pipe.

Use Chart Below:

O.D. of a 5" Schedule 40 Pipe = **5.563" (INCHES)**

Wall Thickness of 5" Schedule 40 Pipe = **.258"**

Wall Thickness multiplied by 2 (.258 x 2) = **.516"**

I.D. of 5" Schedule 40 Pipe (5.563 - .516) = **5.047"**

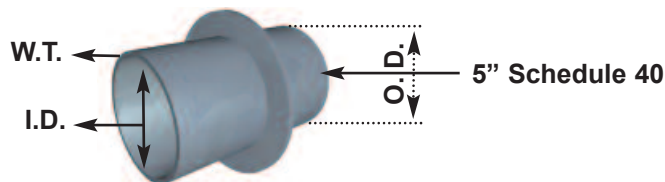

Non Bold = Wall Thickness (Inches) **STD = Standard** **E.H. = Extra Heavy**

Pipe Size	O.D. Inches	SCHEDULE					STD	SCHEDULE		E.H.	SCHEDULE				DBLE. E.H.
		5	10	20	30	40		60	80		100	120	140	160	
1/8"	.405	.035	.049	--	--	.068	.068	--	.095	.095	--	--	--	--	--
1/4"	.540	.049	.065	--	--	.088	.088	--	.119	.119	--	--	--	--	--
3/8"	.675	.049	.065	--	--	.091	.091	--	.126	.126	--	--	--	--	--
1/2"	.840	.065	.083	--	--	.109	.109	--	.147	.147	--	--	--	.188	.294
3/4"	1.050	.065	.083	--	--	.113	.113	--	.154	.154	--	--	--	.219	.308
1"	1.315	.065	.109	--	--	.133	.133	--	.179	.179	--	--	--	.250	.358
1 1/4"	1.660	.065	.109	--	--	.140	.140	--	.191	.191	--	--	--	.250	.382
1 1/2"	1.900	.065	.109	--	--	.145	.145	--	.200	.200	--	--	--	.281	.400
2"	2.375	.065	.109	--	--	.154	.154	--	.218	.218	--	--	--	.344	.436
2 1/2"	2.875	.083	.120	--	--	.203	.203	--	.276	.276	--	--	--	.375	.552
3"	3.500	.083	.120	--	--	.216	.216	--	.300	.300	--	--	--	.438	.600
3 1/2"	4.000	.083	.120	--	--	.226	.226	--	.318	.318	--	--	--	--	.636
4"	4.500	.083	.120	--	--	.237	.237	.281	.337	.337	--	.438	--	.531	.674
4 1/2"	5.000	--	--	--	--	.247	.247	--	.355	.355	--	--	--	--	.710
5"	5.563	.109	.134	--	--	.258	.258	--	.375	.375	--	.500	--	.625	.750
6"	6.625	.109	.134	--	--	.280	.280	--	.432	.432	--	.562	--	.719	.864
7"	7.625	--	--	--	--	--	.301	--	--	.500	--	--	--	--	.875
8"	8.625	.109	.148	.250	.277	.322	.322	.406	.500	.500	.594	.719	.812	.906	.875
9"	9.625	--	--	--	--	--	.342	--	--	.500	--	--	--	--	--
10"	10.750	.134	.165	.250	.307	.365	.365	.500	.594	.500	.719	.844	1.000	1.125	1.000
11"	11.750	--	--	--	--	--	.375	--	--	.500	--	--	--	--	--
12"	12.750	.165	.180	.250	.330	.406	.375	.562	.688	.500	.844	1.000	1.125	1.312	1.000
14"	14.000	--	.250	.312	.375	.438	.375	.594	.750	.500	.938	1.094	1.250	1.406	--
16"	16.000	--	.250	.312	.375	.500	.375	.656	.844	.500	1.031	1.219	1.438	1.594	--
18"	18.000	--	.250	.312	.438	.562	.375	.750	.938	.500	1.156	1.375	1.562	1.781	--
20"	20.000	--	.250	.375	.500	.594	.375	.812	1.031	.500	1.281	1.500	1.750	1.969	--
22"	22.000	--	.250	.375	.500	--	.375	.875	1.125	.500	1.375	1.625	1.875	2.125	--
24"	24.000	--	.250	.375	.562	.688	.375	.969	1.219	.500	1.531	1.812	2.062	2.344	--
26"	26.000	--	.312	.500	--	--	.375	--	--	.500	--	--	--	--	--
28"	28.000	--	.312	.500	.625	--	.375	--	--	.500	--	--	--	--	--
30"	30.000	--	.312	.500	.625	--	.375	--	--	.500	--	--	--	--	--
32"	32.000	--	.312	.500	.625	.688	.375	--	--	.500	--	--	--	--	--
34"	34.000	--	.312	.500	.625	.688	.375	--	--	.500	--	--	--	--	--
36"	36.000	--	.312	.500	.625	.750	.375	--	--	.500	--	--	--	--	--
38"	38.000	--	--	--	--	--	.375	--	--	.500	--	--	--	--	--
40"	40.000	--	--	--	--	--	.375	--	--	.500	--	--	--	--	--
42"	42.000	--	--	--	--	--	.375	--	--	.500	--	--	--	--	--
48"	48.000	--	--	--	--	--	.375	--	--	.500	--	--	--	--	--
54"	54.000	--	--	--	--	--	.375	--	--	.500	--	--	--	--	--
60"	60.000	--	--	--	--	--	.375	--	--	.500	--	--	--	--	--

Disclaimer Note: The above steel pipe O.D.'s are generic, Pipeline Seal and Insulator, Inc. is not a pipe manufacturer. Please always refer to the pipe manufacturer's published/actual values.

Wall Thickness Note: It's suggested sleeves be fabricated from standard (STD) or thicker wall thickness.



Link-Seal® Modular Fire Seals

1-Hour Factory Mutual Approved

Link-Seal® modular fire seals provide up to one-hour protection against flames, smoke, gases and water, even when exposed to temperatures up to 1900°F. (1038°C.).

These seals are a proprietary Link-Seal® modular seal design formulated from Hi-Temp silicone and incorporate special designed carbon steel pressure plates. For installations from 1/2" to 120" diameter Link-Seal® modular fire seals are used with WS wall sleeves or core bit drilled openings.

Model T

One Hour FM Approved

Approved by Factory Mutual as a 1-hour fire stop in accordance with ASTM E814-81 Fire & Hose Stream Criteria Listing #J.I.OH4A5.AC

Model FS or FD

These are essentially two T Models back-to-back for added protection. In Model FS, a tie rod (nut coupler) tightens both seals simultaneously - for use when only one side of a hole is accessible.

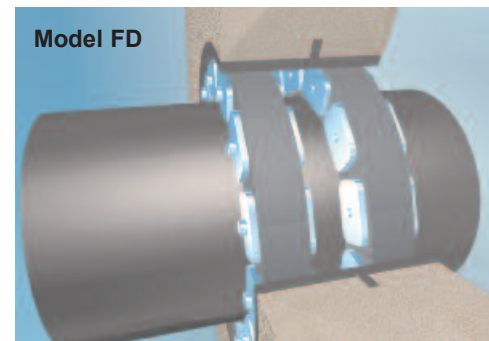
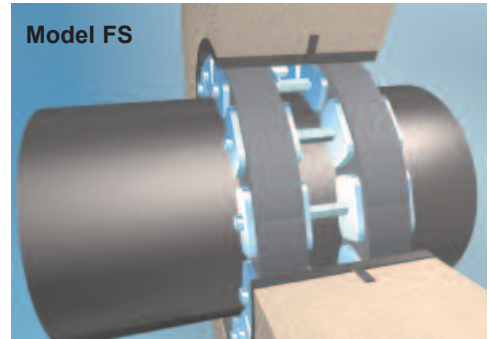
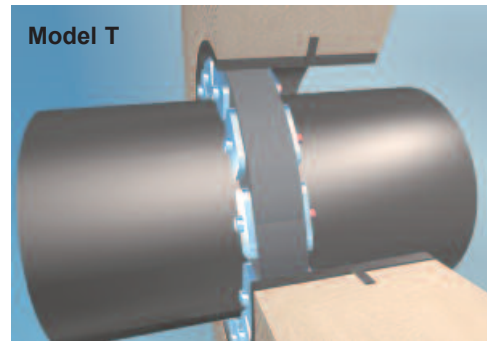

Minimum Wall & Floor Thickness for Model T Fire Rated Seals

LINK-SEAL® MODEL	MINIMUM WALL OR FLOOR THICKNESS
LS-200-T	2.25" (57 mm)
LS-275-T	2.25" (57 mm)
LS-300-T	3.00" (76 mm)
LS-315-T	3.00" (76 mm)
LS-325-T	4.00" (102 mm)
LS-340-T	4.00" (102 mm)
LS-360-T	4.00" (102 mm)
LS-400-T	5.00" (127 mm)
LS-410-T	5.00" (127 mm)
LS-425-T	5.00" (127 mm)
LS-475-T	5.00" (127 mm)
LS-500-T	5.00" (127 mm)
LS-525-T	5.00" (127 mm)
LS-575-T	5.00" (127 mm)

Minimum Wall & Floor Thickness for Model FD or FS Fire Rated Seals

LINK-SEAL® MODEL	MINIMUM WALL OR FLOOR THICKNESS
LS-200-FD or FS	4.50" (114 mm)
LS-275-FD or FS	4.50" (114 mm)
LS-300-FD or FS	6.00" (152 mm)
LS-315-FD or FS	6.00" (152 mm)
LS-325-FD or FS	8.00" (203 mm)
LS-340-FD or FS	8.00" (203mm)
LS-360-FD or FS	8.00" (203mm)
LS-400-FD or FS	10.00" (254 mm)
LS-410-FD or FS	10.00" (254 mm)
LS-425-FD or FS	10.00" (254 mm)
LS-475-FD or FS	10.00" (254 mm)
LS-500-FD or FS	12.00" (305 mm)
LS-525-FD or FS	12.00" (305 mm)
LS-575-FD or FS	12.00" (305 mm)

Link-Seal® Modular Fire Seals - Testing Procedure



Certified test furnace with pipe and cable penetrations and fire rated Link-Seal® modular seal installed in concrete floor slab. Twenty-seven thermo couples were used per slab.



Test slab being raised from furnace at completion of test. (Slab was then positioned vertically for hose stream test.)



Test slab after hose stream. Cold water striking the 1900°F slab caused scalling of concrete, but left Link-Seal® modular seal intact. Unexposed side showed no evidence of water damage.

Sealing Pipeline Casings

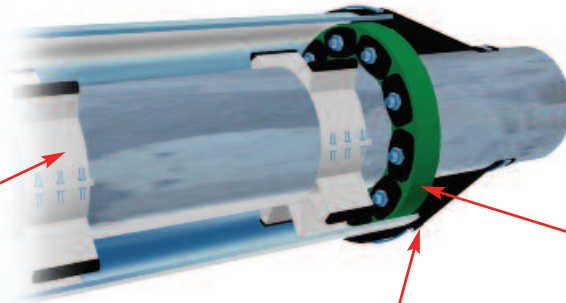

Link-Seal® modular seals with Centering Blocks

PSI Casing Spacers

Metallic

Model C (coated) is available with 8" (208mm) or 12" (305mm) wide steel bands for 4" (10cm) to 120" (305cm) carrier pipe diameters.

Model S (stainless steel) is available with 8" (208mm) or 12" (305mm) wide steel bands for 4" (10cm) to 120" (305cm) carrier pipe diameters.

Plastic

Model PE (polyethylene) is available for 3/4" (19mm) through 48" (1210mm) and larger carrier pipe. (Not recommended for pipe sizes over 12".)

Ranger II all non-metallic spacers are available for 0.83" (21mm) through 37.60" (955mm) carrier pipe diameters.

PSI End Seals

Model "C" Custom Pull-on

Individually designed to accommodate all types of water and sewer pipes and carrier/casing combinations. Made of 1/8" thick, specially compounded synthetic rubber for long life and easy installation.

Model "W" Wrap Around End Seals

Specially designed for ease of installation. Simply remove plastic backing from self-curing rubber and press exposed surfaces together. Available for all carrier/casing differentials.

Model "S" Standard Pull-on End Seals

Made of special synthetic rubber for long life and easy installation, the highly flexible "S" shaped seal is available for ANSI steel pipe specifications. Band locating ribs are on the outside, with special sealing ribs on the inside under the band to prevent leakage.

All PSI End Seals include stainless steel closure clamps.

Link-Seal® Modular Seals with Reinforced Centering Blocks.

A Link-Seal® modular seal assembly installed at each end of pipeline casings provides positive, hydrostatic protection against the entry of water, soil or other backfill materials and reduces corrosion and ice damage.

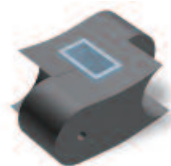

If casing isolators are not used, starting with 14" diameter assemblies, we suggest Link-Seal® modular seals with "centering blocks" in 25% of the links. These centering blocks fit into molded openings in the Link-Seal® modular seals and are positioned in the lower 90° of each assembly. PSI centered casing isolators should also be placed within two feet of casing ends.

400 Series

For Casings Two Pipe Sizes Larger than Carrier Pipe

CARRIER X CASING PIPE IPS Nominal	PLAIN LINKS	COMPLETE CASING SEAL ASSEMBLY CONSISTS OF: LINKS WITH CENTERING BLOCKS	TOTAL LINKS	BASIC LINK-SEAL SIZE USED	COMPLETE ASSEMBLY ORDER NO.
2" X 6"	5	0	5	LS-410	26*
3" X 6"	7	0	7	LS-360	36*
4" X 8"	7	0	7	LS-475	48*
6" X 10"	10	0	10	LS-475	610*
8" X 12"	12	0	12	LS-475	812*
10" X 14"	10	0	10	LS-425	1014*
12" X 16"	12	0	12	LS-425	1216*
14" X 18"	9	4	13	LS-400	1418
16" X 20"	11	4	15	LS-400	1620
18" X 22"	13	4	17	LS-400	1822
20" X 24"	13	5	18	LS-400	2024
22" X 26"	16	5	20	LS-400	2226
24" X 28"	17	5	22	LS-400	2428
26" X 30"	17	6	23	LS-400	2630
28" X 32"	18	7	25	LS-400	2832
30" X 34"	20	7	27	LS-400	3034
32" X 36"	21	8	29	LS-400	3236
34" X 38"	22	8	30	LS-400	3438
36" X 40"	24	8	32	LS-400	3640

* = Centering Blocks are not required and not available for these models. (Maximum coating 3/16" thick - Casing pipe walls should not exceed 0.500" except for casing sizes 12", 14" and 16", which should not have a wall thickness greater than 0.312")

500 Series

For Casings Three Pipe Sizes Larger than Carrier Pipe

CARRIER X CASING PIPE IPS Nominal	PLAIN LINKS	COMPLETE CASING SEAL ASSEMBLY CONSISTS OF: LINKS WITH CENTERING BLOCKS	TOTAL LINKS	BASIC LINK-SEAL SIZE USED	COMPLETE ASSEMBLY ORDER NO.
4" X 10"	6	0	6	LS-500	410**
6" X 12"	7	0	7	LS-500	612**
8" X 14"	11	0	11	LS-575	814**
10" X 16"	7	3	10	LS-525	1016
12" X 18"	9	3	12	LS-525	1218
14" X 20"	9	4	13	LS-500	1420
16" X 22"	11	4	15	LS-500	1622
18" X 24"	12	4	16	LS-500	1824
20" X 26"	13	5	18	LS-500	2026
22" X 28"	14	6	20	LS-500	2228
24" X 30"	15	6	21	LS-500	2430
26" X 32"	17	6	23	LS-500	2632
28" X 34"	18	6	24	LS-500	2834
30" X 36"	19	7	26	LS-500	3036
32" X 38"	21	7	28	LS-500	3238
34" X 40"	21	8	29	LS-500	3440
36" X 42"	23	8	31	LS-500	3642
42" X 48"	27	9	36	LS-500	4248
48" X 54"	30	11	41	LS-500	4854
54" X 60"	34	12	46	LS-500	5460

** = Centering Blocks are not required for these applications. (Maximum coating 3/16" thick - Casing pipe walls should not exceed 0.500" except for casing sizes 16" and 18" which should not have a wall thickness greater than 0.312")



Sealing An Oversize Annulus

The Double Row Method

Sometimes the wall opening represents a differential up to five pipe sizes larger than the carrier pipe itself. This creates an annular space that is larger than the expanded thickness of a single Link-Seal® modular seal assembly. A typical example is a flanged spool piece or an existing opening where piping has been removed to make way for a new installation. As a result it is necessary to use an intermediate sleeve and another belt of Link-Seal® modular seals.

Key design considerations when sizing an intermediate wall sleeve are:

- A. An intermediate sleeve must be used for a proper seal.
- B. The intermediate sleeve should be sized correctly to accommodate both belts of Link-Seal® modular seals.
- C. Be sure to support the actual carrier pipe properly. **Neither belt of links should be responsible for supporting the carrier pipe.**
- D. Let economics guide your selection when sizing Link-Seal modular seals. However do not undersize, refer to adjacent example or call PSI for sizing assistance 1-800-423-2410.

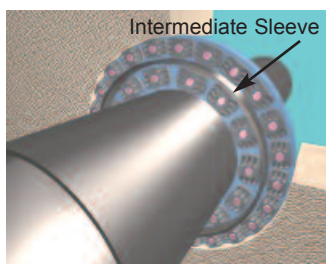

Typical Application

Wall Opening = 40" Cored Hole
 Carrier Pipe = 30" API Type (30.00" O.D.)
 This is a differential of five pipe sizes: (32, 34, 36, 38, 40)

Solution:

Use an inner belt of LS-400 and an outer belt of LS-500.

Intermediate sleeve should be two pipe sizes larger than the 30" carrier pipe. A 34" pipe with a 3/8" wall would be an excellent choice. Checking the Link-Seal® modular seal sizing chart on page 9 indicates a 30 x 34 WS sleeve requires 27 links of LS-400. The outer sleeve of 34 x 40 will require 29 links of LS-500.

For sizing assistance call our toll free number: 1-800-423-2410. Intermediate sleeves available, information pdf file on-line.

Reduce Intermediate Sleeve Applications: Try eliminating your intermediate sleeve needs by sizing the model **LS-650**.



Pressure Testing

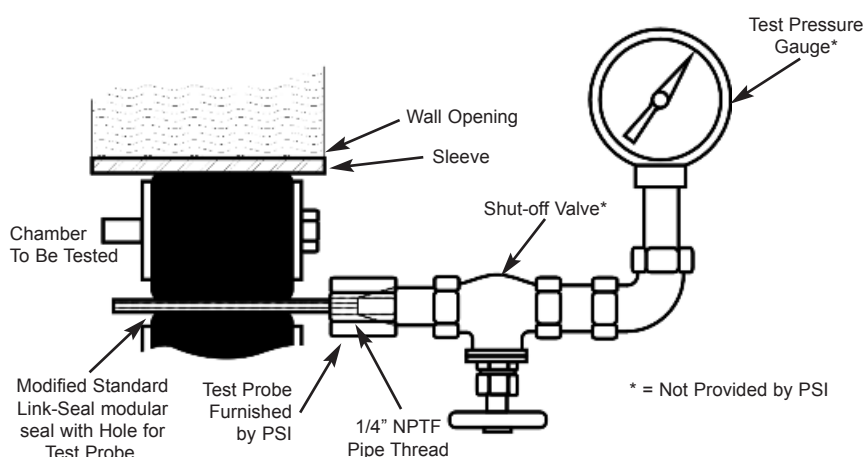

To determine the amount of pressure that has built up behind a Link-Seal® modular seal, install our "V" modification. It is a standard Link-Seal® modular seal assembly in which one link has a hole molded to accept a test probe.

The probe has a NPT female connection and is inserted prior to tightening the assembly. The probe is firmly sealed by expansion of the rubber link. A pressure gauge can then be attached to monitor for leaks or pressure build-up.

How To Order

Please specify "V" with Link-Seal modular seal Model Number Example: LS-400-C-V.

"V" modification NPTF is available in carbon and 304 stainless steel.



Sealing Manhole Penetrations

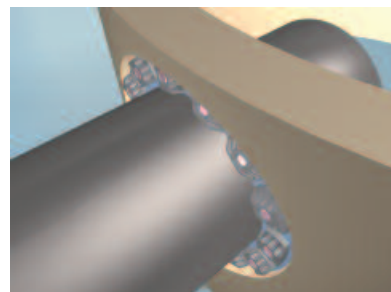

Link-Seal Model Selected for Penetration	(Te) Minimum
LS-200/275	2.25"
LS-300/315	3.00"
LS-325/340/360	4.00"
LS-400/410/425/475	5.00"
LS-500/525/575	5.00"
LS-600/650	6.00"

(Te) = Required bearing surface based on the footprint of respective Link-Seal modular seal model.

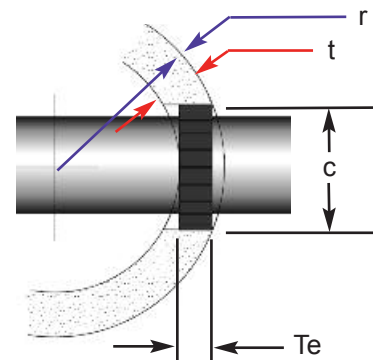

$$Te = t - (r - 1/2 \sqrt{4r^2 - c^2})$$

Example: 3" DI Pipe = LS-315-C-10

t = wall thickness ----- 5"

r = wall outside radius ----- 29"

c = penetration opening I.D. -- 6"

When Link-Seal modular seals are specified for a penetration through a curved wall, the thickness must be checked to assure an adequate sealing surface. A minimum (effective) wall thickness (Te) is required. This can be found by a scale drawing or by using the adjacent formula.





Installation Techniques - Link-Seal® Modular Seals



1. Center the pipe, cable or conduit in wall opening or casing. Make sure the pipe will be adequately supported on both ends. Link-Seal® modular seals are not intended to support the weight of the pipe.

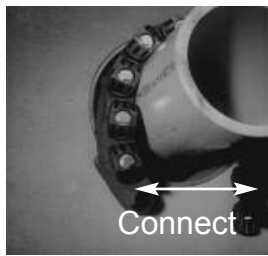

2. Loosen rear pressure plate with nut just enough so links connect freely. Connect both ends of belt around the pipe.



3. Check to be sure all bolt heads are facing the installer. Extra slack or sag is normal. Do not remove links if extra slack exists. **Note:** On smaller diameter pipe, links may need to be stretched.



4. Slide belt assembly into annular space. For larger size belts, start inserting Link-Seal modular seal assembly at the 6 O'Clock position and work both sides up toward the 12 O'Clock position in the annular space.



5. **LS-200 thru. LS-315** Using a hand socket allen head or off-set wrench **ONLY**, start at 12 O' Clock. Do not tighten any bolt more than 4 turns at a time. Continue in a clockwise manner until links have been uniformly compressed. (Approx. 2 or 3 rotations)



5a. **LS-325 thru. LS-650** Using a hand socket or off-set wrench **ONLY**, start at 12 O' Clock. Do not tighten any bolt more than 4 turns at a time. Continue in a clockwise manner until links have been uniformly compressed. (Approx. 2 or 3 rotations)

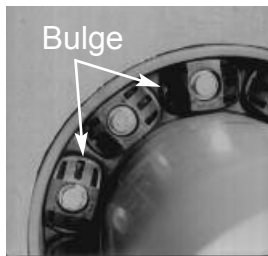

6. Make 2 or 3 more passes at 4 turns per bolt **MAXIMUM**, tightening all bolts clockwise until all sealing elements "**bulge**" around all pressure plates. On type 316 stainless steel bolts, hand tighten **ONLY** without power tool.

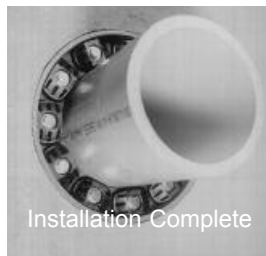

7. If the seal doesn't appear to be correct using the instructions provided, **Call PSI at 800-423-2410.**

Link-Seal® Model	Tool Size/ Type Req.	Bolt Head
LS-200, LS-275	4mm, Allen	
LS-300, LS-315	6mm, Allen	
LS-325, LS-340, LS-360	13mm, Hex	
LS-400, LS-410, LS-425, LS-475	17mm, Hex	
LS-500, LS-525, LS-575	19mm, Hex	
LS-600	30mm, Hex	
LS-650	19mm, Hex	

Installation Notes: The Link-Seal® modular seal bolt heads are usually recessed below the wall opening or the edge of casing pipe and therefore a socket or offset wrench must be used. **Hand Tools:** Review provided chart above. (Tools not provided.) Tools can be purchased from hardware store, auto parts store, or home improvement store.

Always Wear Safety Equipment When Using Link-Seal® Modular Seals!

Link-Seal® Modular Seal - Do's



1. Make sure pipe is centered.
2. Install the belt with the pressure plates evenly spaced.
3. Install the exact number

- of links indicated in sizing charts.
4. Check to make sure pipe is supported properly during backfill operations. Note: Link-Seal modular seals are not intended to support the weight of the pipe.
5. Make sure seal assembly and pipe surfaces are free from dirt.
6. For tight fits, use non-polluting liquid detergent to assist installation.

Link-Seal® Modular Seal - Don'ts

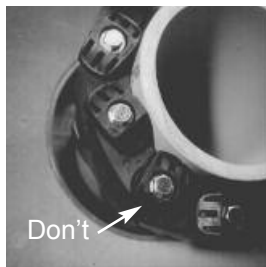

1. Don't Install the belt with the pressure plates aimed in irregular directions. (Staggered)

2. Don't Install Link-Seal® modular seals where weld-beds or other irregular surfaces exist without consideration of the sealing requirements.
3. Don't torque each bolt completely before moving on to the next.
4. Don't use high speed power tools (450 rpm or more)
5. Do not use power tools on Link-Seal modular seal 316 stainless steel bolts.
6. Don't use grease installing Link-Seal modular seals.



If the seal doesn't appear to be correct using the techniques provided, **Call PSI at 713-747-6948 or 800-423-2410.**



Installation Techniques - Century-Line® Sleeves

Century-Line® Sleeves are thermoplastic wall or floor pipe penetration sleeves. One person working alone can usually install a Century-Line® Sleeve regardless of the size.



1. Measure the center line to position Century-Line® Sleeve end cap.



2. Nail one of the end caps at the marked center line. A 2" minimum clearance is suggested when nesting sleeves.



3. Place the Century-Line® Sleeve on the end cap. *When field cutting non standard CS sleeve lengths, the sleeve and endcaps total length should be one-fourth (1/4") longer than the thickness of the wall.* Cut with a hand or power saw.



4. Place second end cap on sleeve. Check to determine that the cap is properly inserted.

Always Wear Safety Equipment When Using Century-Line Sleeves & Link-Seal Modular Seals!



5. For additional stability, it's necessary to secure the sleeve with wire to the rebar. Insert the other end cap firmly, check that second end cap is positioned correctly, confirm sleeve length and close the form.



6. After the concrete is poured and cured, remove end caps with screw driver or crow bar. End caps may be replaced to protect sleeve until pipe penetration is made.

Note: To insure minimum water migration, center the water stop in wall by cutting equal lengths from each end of the sleeve, except as noted below.

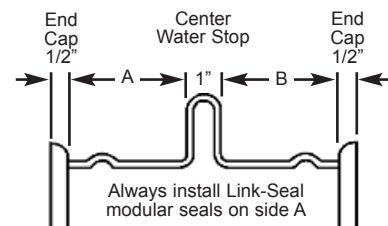

Wall Thickness	Cut From Left End	Dimension A	Cut From Right End	Dimension B
16"	0.0"	7.125"	0.0"	7.125"
14"	.875"	6.125"	.875"	6.125"
12"	1.875"	5.125"	1.875"	5.125"
10"	2.375"	4.625"	3.375"	3.625"
8"	2.375"	4.625"	5.375"	1.625"

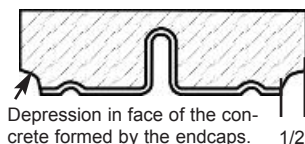

Depression in face of the concrete formed by the endcaps. 1/2"

Notes:

- Example: To convert 16" to 12", cut 1.875" off each end.
- Endcaps leave 1/2" depression in face of concrete.
- On sleeves under 12" length, install Link-Seal® modular seal on the "long side" of the waterstop.
 - For Link-Seal® modular seals models LS-200, LS-275, LS-300, LS-315, LS-340 and LS-360 - install with pressure plates flush with outer edge of the sleeve.
 - For Link-Seal® modular seals models LS-325, LS-400, LS-410, LS-425 and LS-475 - install with pressure plates partially inserted into the sleeve. When tightened, the pressure plates will "pull" into the sleeve.
 - For Link-Seal® modular seals models LS-500, LS-525, LS-575, LS-600 and LS-650 - the minimum sleeve length is 10". Follow the instructions in 3 above.

Alternative Technique Using Threaded Rod



After nailing end cap to form, drive (threaded rod*) through the end plate and form and (thread nut*) on other side. **Note:** Remember to measure the (threaded rod*) to match the length of the sleeve.

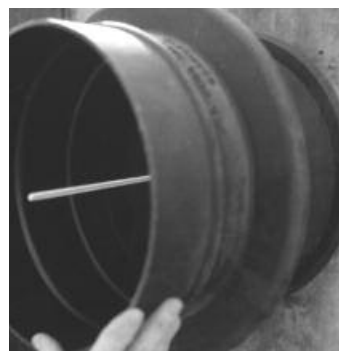

Place the sleeve over the end cap nailed to the form.

* = Not Provided by PSI.



Place second cap on the sleeve and use a (block of wood*) and (wing nut*) to tighten unit in place. Make certain sleeve is plumb.

If you should have questions using the techniques provided, Call PSI at 713-747-6948 or 800-423-2410.

Installation Techniques - Cell-Cast® Disks



1. Locate center line where the hole is desired. This location will be used as a guide for the threaded centering assist rod.



2. A 2x4 wood nailer is included. Fasten it along with the threaded rod directly to the concrete form. This provides support and helps center the complete Cell-Cast® disk assembly.



3. Slide the first Cell-Cast® disk over the *threaded rod. **Note:** Use only 1 threaded rod for equal distribution. More than one rod could take disks out of shape.



4. Secure the edges of the cell to the form using the provided steel spikes.



5. Additional disks are interlocked to accommodate finished wall thickness. Verify thickness is the same as wall.



6. Guide the 1" wood block over the threaded rod and secure the assembly with the wing nut provided.



7. Wrap each seam with one wrap of 2" wide tape to bridge any possible gaps. **Note:** Tape not included. Finish installing concrete forms and pour concrete.



8. After wall cures, wall forms are removed. The Cell-Cast® disk assembly is now ready for removal.



9. Chip excess concrete from the edge of the Cell-Cast® disk assembly and wall.



10. Remove disks by breaking out the entire assembly.



11. Inspect the installation. A smooth opening is important for a proper Link-Seal® modular seal installation. Repair voids and grind smooth any ridges.

If you should have questions using the techniques provided, Call PSI at 713-747-6948 or 800-423-2410.

Note: For walls greater than 16", please contact PSI.

***Note:** Threaded rod must be requested when ordered. Make sure TRA is added to the end of the ordering code.

Always Wear Safety Equipment When Using Cell-Cast® Disks!



Product Ordering Code

Link-Seal® Modular Seals with Century-Line Sleeves

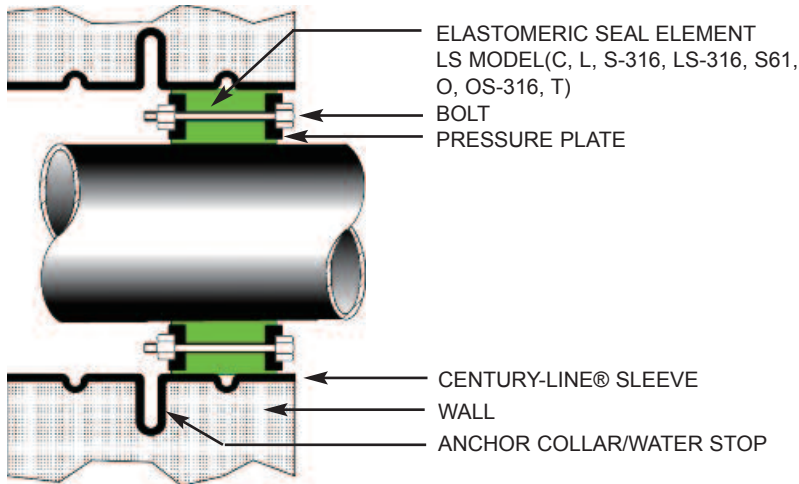

LINK-SEAL® MODEL NO. EXAMPLE
LS - 400 - C - 10

LINK-SEAL® _____
 SIZE _____
 MODEL _____
 NO. OF LINKS _____

CENTURY-LINE® MODEL NO. EXAMPLE
CS - 10 - 16 - 1

CS SLEEVE MODEL NO. _____
 SLEEVE LENGTH (INCHES) _____
 NO. OF UNITS _____

Link-Seal® Modular Seals with Model WS Wall Sleeves

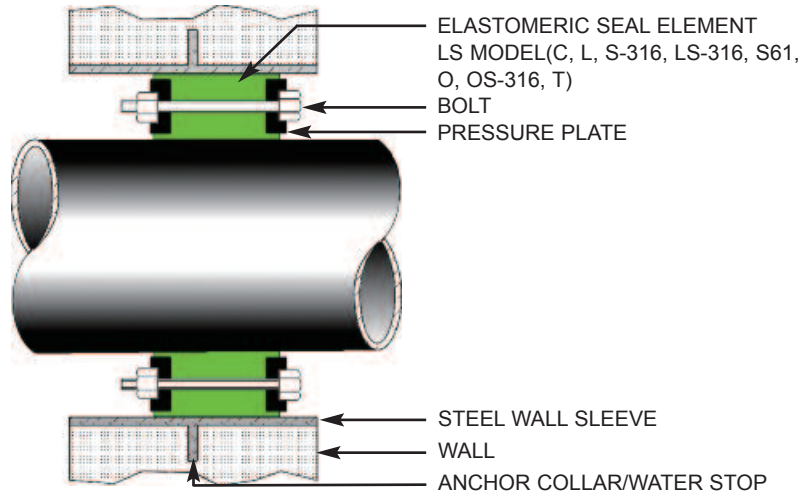

LINK-SEAL® MODEL NO. EXAMPLE
LS - 400 - C - 10

LINK-SEAL® _____
 SIZE _____
 MODEL _____
 NO. OF LINKS _____

STEEL WS SLEEVE MODEL NO. EXAMPLE
WS - 14 - 25 - S - 12

WALL SLEEVE _____
 SLEEVE NOMINAL _____
 STEEL WALL THICKNESS _____
 STEEL _____
 LENGTH IN INCHES _____

Link-Seal® Modular Seals with Cast, Core Drilled or Cell-Cast® Disk Wall Opening

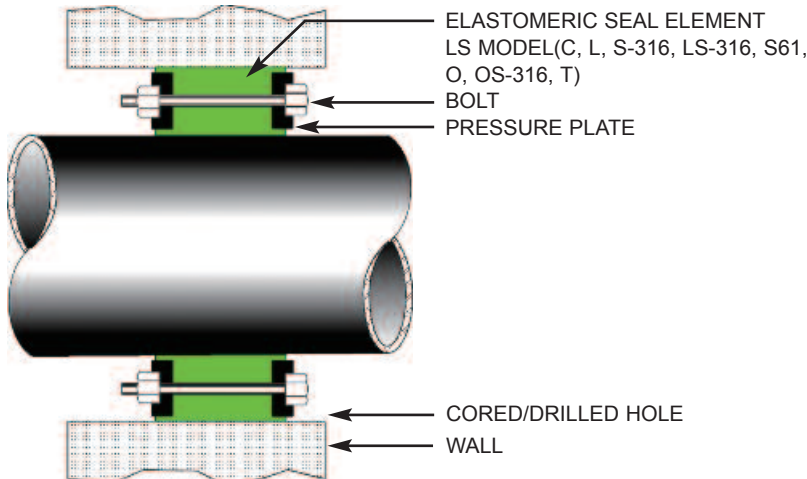

LINK-SEAL® MODEL NO. EXAMPLE
LS - 400 - C - 10

LINK-SEAL® _____
 SIZE _____
 MODEL _____
 NO. OF LINKS _____

CELL-CAST DISK® MODEL NO. EXAMPLE
CC - 30 - (3)2 - (4)2

CELL-CAST® MODEL NO. _____
 NO. 3" Disks _____
 NO. 4" Disks _____

Note: Creating a 30" (29.25" I.D.) Hole with a 14" Wall Thickness. Specify TRA at the end of the ordering code for threaded rod assembly.



CAD (.dwg) Drawings Available On-line.
 Visit www.linkseal.com

Typical Specification



Typical Specification

1.0 General

Under this section there shall be furnished and installed a complete Link-Seal® modular seal assembly, manufactured by PSI-Thunderline/Link-Seal® located at 6525 Goforth Street, Houston, TX 77021, as shown on drawings and specifications. For clarification, complete assembly is defined as a combined:

- A. Wall (Floor, Ceiling) opening (i.e. steel sleeve, Thermoplastic (HDPE) sleeve, cored hole or formed hole). The wall opening size and/or type shall be selected according to information found in the most recent Link-Seal® modular seal catalog.
- B. Sufficient quantity and type of Link-Seal® modular seals required to effectively provide a hydrostatic and/or fire-rated seal.
- C. Each individual link shall be conspicuously and permanently identified with the name of the manufacturer and model number. Manufacturers other than the above-named company wishing to quote equipment in this section shall submit detail drawings of their proposed equipment and suitable evidence of a minimum of 25 years of experience and results to the engineer to obtain written approval to quote at least ten (10) days prior to bid opening.

2.0 Link-Seal® Modular Seal Rubber Links

Shall be modular, mechanical type, consisting of inter-locking synthetic rubber links shaped to continuously fill the annular space between the pipe and the wall opening. The elastomeric element shall be sized and selected per manufacturer's sizing procedure and have the following properties as designated by ASTM. Coloration shall be throughout elastomer for positive field inspection. Each link shall have a permanent identification of the size and manufacturer's name molded into it.

- A. For Standard Service Applications = Model C
-40 to +250°F (-40 to +121°C)
EPDM = ATSM D2000 M3 BA510 Color = Black
- B. For Potable Water/NSF 61 Service Applications = Model S61
-40 to +250°F (-40 to +121°C)
EPDM = ATSM D2000 M3 BA510 Color = Black
- C. For Thin Walled Pipe Applications = Model L
-40 to +250°F (-40 to +121°C)
EPDM = ATSM D2000 M3 BA510 Color = Blue
- D. For Hydrocarbon Service Applications = Model O
-40 to +210°F (-40 to +99°C)
Nitrile = ASTM D2000 M1BF510 Color = Green
- E. For High Temperature or Fire Seal Applications = Model T
-67 to +400°F (-55 to +204°C)
Silicone = ASTM D2000 M1GE505 Color = Gray
Reference shall always be made to the latest published Link-Seal® modular seal selection guide for the service intended.

2.1 Link-Seal® Modular Seal Pressure Plates

- A. Link-Seal® modular seal pressure plates shall be a uniform pressure plate design molded of glass reinforced Nylon Polymer with the following properties:
Izod Impact - Notched = 2.05ft-lb/in. per ASTM D-256
Flexural Strength @ Yield = 30,750 psi per ASTM D-790
Flexural Modulus = 1,124,000 psi per ASTM D-790
Elongation Break = 11.07% per ASTM D-638
Specific Gravity = 1.38 per ASTM D-792

- B. Models LS200-275-300-315 shall incorporate the most current Link-Seal® Modular Seal design modifications and shall include an integrally molded compression assist boss on the top (bolt entry side) of the pressure plate, which permits increased compressive loading of the rubber sealing element. Models 325-340-360-400-410-425-475-500-525-575-600 shall incorporate an integral recess known as a "Hex Nut Interlock" designed to accommodate commercially available fasteners to insure proper thread engagement for the class and service of metal hardware. All pressure plates shall have a permanent identification of the manufacturer's name molded into it.
- C. For fire and Hi-Temp service, pressure plates shall be steel with 2-part Zinc Dichromate Coating.

2.2 Link-Seal® Modular Seal Hardware

All fasteners shall be sized according to latest Link-Seal® modular seal technical data. Bolts, allen head/flange hex nuts shall be either:

- A. Mild Steel with a 60,000 psi minimum tensile strength and 2-part Zinc Dichromate coating per ASTM B-633 and Organic Coating, tested in accordance with ASTM B-117 to pass a 1,470 hour salt spray test.
- B. 316 Stainless Steel per ASTM F593-95, with a 85,000 psi average tensile strength.

3.0 Wall Opening

- A. **Century-Line® Sleeves - for openings to 24.75" diameter.**
Where pipes must pass through walls and floors of new structures, unless otherwise shown or specified, install molded non-metallic high density polyethylene Model CS Century-Line® sleeves as manufactured by PSI-Thunderline/Link-Seal®. Model CS sleeves shall have integrally formed hollow water stop sized having a minimum of four inches larger than the outside diameter of the sleeve itself and allowing 1/2" movement between wall forms to resist pour forces. Each sleeve assembly shall have end caps manufactured of the same material as the sleeve itself and installed at each end of the sleeve so as to prevent deformation during the initial concrete pour, and to facilitate attaching the sleeve to the wall forms. End caps shall remain in place to protect the opening from residual debris and rodent entry prior to pipe insertion.
- B. **Cell-Cast® Disks - for openings from 29.25" to 64.74" diameter.**
The contractor shall install Cell-Cast® disks, providing a round hole in conformance with Link-Seal® modular seal sizing data. Cell-Cast® disks shall consist of 3" and/or 4" lightweight interlocking polyethylene cells stacked to form the thickness of the poured concrete wall. Molded into each cell shall be a cavity to accept a 2" x 4" nailer.

4.0 Quality Assurance

Link-Seal® Modular Seal components and systems shall be domestically manufactured at a plant with a current ISO 9001:2008 registration. Copy of ISO 9001:2008 registrations shall be a submittal item.

NOTE: Link-Seal Modular Seals are specifically designed as hydrostatic and/or fire rated seals and are not considered to be pipe supports. When appropriate, Link-Seal Modular Seals should be used with proper pipe supports on both ends.

Frequently Asked Questions



1) Q - Can Link-Seal® modular seals be used with pipe types not listed in the standard published charts?

A - Yes, The best way to permanently seal any cylindrical object, of any size, passing through any type of concrete barrier is to use Link-Seal modular seals. From ductile iron to pre-stressed concrete to metal or plastic pipe, conduit or cables - whatever your application - Link-Seal modular seals will effect a hydro-static seal capable of holding 20 psig (40 feet of static head) between the pipe and the penetration cylinder through which the pipe passes.

2) Q - How much angular pipe movement will Link-Seal® modular seals allow and still maintain a seal?

A - Link-Seal modular seals may allow angular pipe movement or misalignment depending on the ratio of annular space of the penetration to the expanded range of the Link-Seal model sized for the penetration. Please call PSI for more information.

3) Q - When is the recommended time to install Link-Seal® modular seals?

A - Always install Link-Seal modular seals prior to any final connections. This helps prevent off-center pipe alignment.

4) Q - Is it necessary to use WS or CS sleeves when installing Link-Seal® modular seals?

A - WS model steel and CS model HDPE sleeves are specially designed for use with Link-Seal modular seals. When installed with Link-Seal modular seals these sleeves provide the best possible assurance of a quality wall penetration system.

5) Q - What tools are required to install Link-Seal® modular seals?

Link-Seal® Model	Tool Size/Type Req.
LS-200, LS-275	4mm, Allen
LS-300, LS-315	6mm, Allen
LS-325, LS-340, LS-360	13mm, Hex
LS-400, LS-410, LS-425, LS-475	17mm, Hex
LS-500, LS-525, LS-575	19mm, Hex
LS-600	30mm, Hex
LS-650	19mm, Hex

A - A low speed (450 RPM or less) power tool is suggested for multiple installations to increase efficiency with carbon steel hardware.

6) Q - Can I use power tools when installing Link-Seal modular seals with 316 stainless steel bolts?

A - No, please refer to suggested installation techniques.

7) Q - Sometimes when installing a Link-Seal® modular seal belt, it hangs loose on the pipe even though all my sizing calculations are correct. Why does it appear that I have too many links?

A - Link-Seal modular seals are basically sized to fit the annular space, not the pipe. Use the assemblies suggested by the charts or calculation. It may not look right, but it will fit.

8) Q - Can Link-Seal® modular seals be used for penetrations where the pipe is off-center to the opening?

A - Centering is very important. Contact PSI for more information.

9) Q - How do I install Link-Seal® modular seals over a weld-bead?

A - Weld-beads and all other irregularities on the pipe or opening should be addressed in accordance with the manufacturer's and/or project engineer's suggestions to provide a round, smooth and clean surface for Link-Seal installation.

10) Q - My wall is 24" thick. Do I need Link-Seal® modular seals on both sides of the wall?

A - In many cases, one single Link-Seal modular seal assembly is appropriate. Double seals are typically found in critical applications such as fire walls or nuclear power stations. Double seals are also suggested for building foundation wall penetrations where the wall thickness is greater than 12".

11) Q- Can Link-Seal® modular seals be used with man-hole vault installed thimbles, not sleeves?

A- No, only if the area creates a penetration cylinder, such that the axis of the cylinder is parallel to the axis of the pipe going through it.

12) Q- Can lubricant be used to install Link-Seal® modular seals?

A- Yes, any non-polluting liquid detergent is preferred over a grease. If you need to use grease or another lubricant, please contact PSI.

13) Should you grout over Link-Seal® modular seals?

A- Link-Seal modular seals do not require any assistance to create a water tight seal, if they are installed per our published installation techniques. Any material placed between the seal and the ID of the penetration is not recommended. However, if grout is needed for appearance purposes only, it's suggested that the links be installed far enough into the penetration to accommodate a layer of "bubble wrap". If the pipe needs future maintenance the grout can be removed and access can be gained to the bolts of the Link-Seal modular seal.

14) What model Link-Seal® modular seals should be used for submerged sea water applications?

A- For submerged sea water applications use Model S-316 Link-Seal® modular seals. See page 5 for material property information.

15) Why is it sometimes difficult to seal an insulated pipe with Link-Seal® modular seals?

A- Jacket thickness, or more importantly, its ability to maintain its diameter without deforming is key to success of the Link-Seal® modular seal's ability to seal. If the jacket withstands the constricting force of the Link-Seal modular seal without cracking or deforming, Link-Seal modular seals are effective. If the jacket "gives", much like an aluminum can, the jacket will crack enabling water to go directly into the insulation and by pass the Link-Seal modular seal installation.

16) Q - Is it necessary to use riser clamps, pipe saddles and hanger supports with Link-Seal® modular seals?

A - Link-Seal modular seals are penetration type seals. It is not intended to be a structural support. Standard pipe hanger practice should always be applied.

17) Q - Why are torque values not used to install Link-Seal® Modular Seals?

A - Every penetration has unique parameters; OD, ID, surface smoothness, ratios of annular space to expanded range. Follow Step #6 in the Published Installation Techniques for proper installation.

Updated engineering catalogs, literature, CAD Drawings, submittals and installation techniques are available on-line at: www.linkseal.com



**Calling-out the Original
Link-Seal® Modular Seal System.
The System is the Solution!**

Warranty and Conditions of Sale

The seller warrants that all goods furnished under this order will be free from defects in material and workmanship and will conform to Pipeline Seal & Insulator, Inc. published specifications.

The limit of Pipeline Seal & Insulator, Inc.'s liability for failure of any of our products to meet the foregoing warranty, or for breach of any other warranty, express, implied or statutory, shall be to supply an equivalent amount of product for any materials returned to us within 12 months of shipment and found to be defective by Pipeline Seal & Insulator, Inc.

Due to the widely varying conditions under which our products are used or installed, Pipeline Seal & Insulator, Inc. offers no warranty as to their merchantability, length of service or suitability for any particular purpose, express or implied, other than described above.

The Purchaser accepts full responsibility for installation of all goods furnished under this order and for any defects or damage suffered as a result of defective installation of such goods. No instructions, advice, or aid relative to installation given by the Seller to the Purchaser shall be construed as a warranty as to the accuracy or utility of such instructions, advice, or aid, but only as an accommodation to the Purchaser and an opinion of the Seller.

The foregoing conditions of sale shall not be modified or affected in any way whatsoever by reason of Seller's receipt or acknowledgement of Buyer's purchase order or any other related instrument of paper containing additional or different conditions and, to the extent there may be any terms or provisions in such a purchase order, etc. which may be in conflict with or modification of the foregoing, such terms and provisions of such purchase order, etc. shall be deemed to have no force or effect.

Tighten Your Specifications!

Approvals:ISO 9001:2008, Factory Mutual, NSF 61	
Elastomers:EPDM, Nitrile, Silicone	
Made in America (U.S.A)	Yes
Permanent Identification	Yes
Corrosion Resistant Fasteners	
316 Stainless as Standard	Yes
16 Model Sizes	Yes
Hi/Low Temp. Seals	Yes
FM Approved Fire Seals, NSF 61 Certified	Yes
Bolts available in Metric Format	Yes
Bolts pass 1470 hour salt spray test	Yes
Non-conductive CS Molded	
Sleeve Penetration System	Yes
Low torque Pressure Plate and Elastomer	Yes
Special "V" Modification Pressure Monitoring	Yes
Color Coded Elastomers and Pressure Plates	Yes
Cell-Cast® Hole Forms	Yes
On Staff Seal Engineering Assistance	Yes
Worldwide Stocking Distributors	Yes
Bolt and Nut Specifications per ASTM Standards	Yes
Universal Pressure Plate Design	Yes

(See Link-Seal® Modular Seal specification, section 2.2, on page 26)

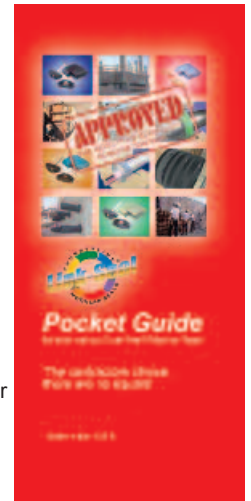

Pocket Guides - For the contractor in the field. Contact your local distributor for printed material.

Disclaimer

Please note, failure to select the correct materials or products we supply ("the Products") may result in damage to plant, equipment or property. In some instances, it may cause death or personal injury. We are not designers and do not give advice about design related matters concerning the Products. We can help and assist with the technical specifications for the Products. In specific applications, particularly where critical conditions exist, we will try to assist you within the limitations of the services that we offer. All information supplied by us is intended as technical co-operation outlining the specifications of the different Products which we supply. To the extent permitted in law, no warranty is given in respect of any information supplied by us. The customer must satisfy themselves as to the suitability of the Products for their intended application and use. The correct fitting of Products is the responsibility of the customer. Your statutory rights remain unaffected. Save in respect of death, personal injury or fraud, our entire liability to you, however arising from the supply of Products shall be limited to the £10M indemnity amount provided by our insurers.

**WILLIAM JOHNSTON
& COMPANY LIMITED**

Glasgow Tel: +44 (0) 141 620 1666 | Inverness Tel: +44 (0) 1463 238 673
sales@williamjohnston.co.uk | www.williamjohnston.co.uk

YOUR OFFICIAL UK DISTRIBUTOR FOR LINK-SEAL